

## Preface

Thank you for purchasing Digital's Pro-face GP-270 Series of Graphic Control Panels (hereafter referred to as the *GP unit*).

This GP unit, with its advanced user functions and improved performance, is an upgrade from the earlier GP-250 Series.

Please read this manual carefully as it explains, step by step, how to install and use the GP correctly.

In its examples, this manual uses the Mitsubishi MELSEC-AnA Series of PLC's wherever possible, connected in a one-to-one relationship with the GP.

**GP-270 Series** refers to the following GP model numbers:

GP270-LG11, GP270-SC11(Standard item)

GP270-LG21, GP270-SC21(CE marked units)

GP270-LG31, GP270-SC31(UL/cUL(CSA) marked units)

<Note>

- 1) It is forbidden to copy the contents of this manual, in whole or in part, except for the user's personal use, without expressed permission from Digital Electronics Corporation of Japan
- 2) The information provided in this manual is subject to change without notice.
- 3) This manual has been written with care and attention to detail; however, should you find any errors or omissions, please contact Digital Electronics and inform them of your findings.
- 4) Please be aware that we are not responsible for any damages resulting from the use of our products, regardless of article 3 above.

All company/manufacturer names used in this manual are the registered trademarks of their respective companies.

© Copyright March 1996, Digital Electronics Corporation

# Table of Contents

## PREFACE

Table of Contents .....	ii
Essential Safety Precautions .....	v
UL/cUL (CSA) Application Notes .....	vii
CE Marking Notes .....	viii
What is IP65f? .....	viii
Package Contents .....	ix
Separately Sold Manual .....	ix
Documentation Conventions .....	x

## CHAPTER 1 - INTRODUCTION

1.1 Before Operating GP .....	1-1
1.2 System Structure .....	1-2
1.3 Optional Equipment .....	1-5

## CHAPTER 2 - SPECIFICATIONS

2.1 General Specifications .....	2-1
1. Electrical Specifications .....	2-1
2. Environmental Specifications .....	2-1
2.2 Function and Performance .....	2-2
1. Display Functions .....	2-2
3. Structural Specifications .....	2-2
2. Screen Memory .....	2-3
3. Touch Panel / Clock Accuracy .....	2-3
4. External Interface .....	2-3
2.3 Interface Specifications .....	2-4
1. Serial Interface .....	2-4
2.4 Names and Functions of GP Parts .....	2-5
2.5 Graphic Panel Dimensions .....	2-6
1. GP-270 External Dimensions .....	2-6
2. Installation Brackets .....	2-7
3. GP Installation Dimensions .....	2-8

## CHAPTER 3 - INSTALLATION AND WIRING

3.1 Installation .....	3-1
1. Installation .....	3-1

## Preface

<b>3.2</b>	<b>Wiring .....</b>	<b>3-5</b>
1.	Power Cable Connection .....	3-5
2.	Precaution: Grounding .....	3-6
3.	Precaution: Input/Output Signal Lines .....	3-6
<b>3.3</b>	<b>Tool Connector .....</b>	<b>3-7</b>

### CHAPTER 4 - OFF-LINE MODE

<b>4.1</b>	<b>Entering Off-line Mode .....</b>	<b>4-1</b>
1.	When Turning the Unit On .....	4-1
2.	Enter From Force Reset .....	4-2
<b>4.2</b>	<b>Main Menu .....</b>	<b>4-3</b>
<b>4.3</b>	<b>INITIALIZE—Standard Operations .....</b>	<b>4-4</b>
<b>4.4</b>	<b>SELF-DIAGNOSIS—Standard Operations .....</b>	<b>4-5</b>
<b>4.5</b>	<b>Transfer Screen Data .....</b>	<b>4-7</b>

### CHAPTER 5 - INITIALIZE

<b>5.1</b>	<b>Initialize Screen .....</b>	<b>5-1</b>
<b>5.2</b>	<b>Initialize Items .....</b>	<b>5-2</b>
<b>5.3</b>	<b>SYSTEM ENVIRONMENT SETUP .....</b>	<b>5-3</b>
1.	SYSTEM SETUP .....	5-3
2.	SYSTEM AREA SETUP .....	5-4
3.	GLOBAL WINDOW SETUP .....	5-5
4.	CHARACTER STRING DATA SETUP .....	5-6
<b>5.4</b>	<b>SET UP I/O .....</b>	<b>5-9</b>
1.	SET UP SIO .....	5-9
2.	SET UP I/O .....	5-10
3.	COMMUNICATION SETUP .....	5-12
<b>5.5</b>	<b>PLC SETUP .....</b>	<b>5-13</b>
1.	SET UP OPERATION SURROUNDINGS (1:1) .....	5-13
2.	SET UP OPERATION SURROUNDINGS (n:1) .....	5-14
3.	STATION SETUP (n:1) .....	5-15
4.	CUSTOMIZE SETUP .....	5-17
<b>5.6</b>	<b>INITIALIZE MEMORY .....</b>	<b>5-19</b>
<b>5.7</b>	<b>SET UP TIME .....</b>	<b>5-19</b>
<b>5.8</b>	<b>SET UP SCREEN .....</b>	<b>5-20</b>
<b>5.9</b>	<b>FONT SETTING .....</b>	<b>5-21</b>

**CHAPTER 6 - RUN AND ERRORS**

<b>6.1</b>	<b>RUN</b> .....	<b>6-1</b>
1.	Powering Up.....	6-1
2.	Off-line Mode .....	6-1
<b>6.2</b>	<b>Troubleshooting</b> .....	<b>6-2</b>
1.	Troubles .....	6-2
2.	No Display .....	6-4
3.	Would Not Communicate .....	6-7
4.	The Touch Panel Does Not Work .....	6-9
<b>6.3</b>	<b>SELF-DIAGNOSIS</b> .....	<b>6-10</b>
1.	SELF-DIAGNOSIS Item List .....	6-10
2.	SELF-DIAGNOSIS—Details Of Each Item .....	6-11
<b>6.4</b>	<b>Error Message</b> .....	<b>6-14</b>
1.	Error Message List.....	6-14
2.	Error Messages—Details.....	6-15

**CHAPTER 7 - MAINTENANCE**

<b>7.1</b>	<b>Regular Cleaning</b> .....	<b>7-1</b>
<b>7.2</b>	<b>Periodic Check-Up</b> .....	<b>7-2</b>
<b>7.3</b>	<b>Changing the Backlight</b> .....	<b>7-3</b>

**INDEX**

# Essential Safety Precautions

This manual includes procedures that must be followed to operate the GP correctly and safely. Be sure to read this manual and any related materials thoroughly to understand the correct operation and functions of this unit.

## Icon Meaning

To allow you to use the GP correctly, throughout this manual, the following icons are provided next to operations requiring special attention. The operations described with these icons contain essential safety information. The following is an example of these icons and their meanings:



Indicates situations where severe bodily injury, death or major equipment damage can occur.



Indicates situations where slight bodily injury or machine damage can occur.



## WARNINGS

- **Confirm that the GP's Power Cord is not plugged in to the main power when connecting the GP's power terminals.**
- **Whenever changing the Backlight, to prevent electric shocks or burns, be sure to unplug the GP's powercord and use protective gloves.**
- **The GP contains high voltage parts and electric shocks can occur when disassembling the unit. *Do not disassemble the GP.***
- **Do not use power beyond the GP's specified voltage range. If you do, it may cause a fire or an electric shock.**
- **Do not use the GP in an environment where flammable gas is present. It may cause explosion.**
- **Do not use touch panel keys in life-related or important disaster prevention situations. Use separate hardware switches for such keys.**
- **Please design your system so that the machine will not malfunction by a communication fault between the GP and its host controller. If not, there could be a danger of injuring a person or damaging materials.**

 **CAUTIONS**

- The GP uses a lithium battery for backing up its internal clock data. If the battery is incorrectly replaced, it may explode. To avoid this danger, please consult with your local GP distributor when the battery needs replacement.
- Do not strike the GP's touch panel with a hard or heavy object, or press on the touch panel too strongly since it may damage the display.
- Do not install the GP where the temperature will exceed its specified range.
- Be sure that water, liquids or metal particles do not enter the GP, since it may cause a malfunction or a short circuit.
- Do not store or use the GP where powerful shocks or vibration are likely to occur.
- Do not store or use the GP where chemicals and acids are present in the air.
- Do not use paint thinner or organic solvents to clean the plastic case or display panel.
- Be sure to back up your GP's screen data regularly.

**Concerning the GP's Display**

- The following LCD characteristics are normal and are not evidence of a defect.
  - 1) Contouring, i.e. when some parts of the screen are brighter than others, may occur, creating a wavelike pattern.
  - 2) Minute grid-points (dark/ light).
  - 3) Shadows (At the top of the LCD).
  - 4) Display colors appear to have changed.
- Preventing Afterimages:
  - Set the unit to "Stand-by Mode", which will turn the GP's display OFF after a period of non-use.
  - Do not display any single screen for an extended period of time. Change the screen display periodically.

# UL/cUL Application Notes

---

The GP270-LG31-24V and GP270-SC31-24V are cUL 1950 (+ D3) recognized products. Please pay special attention to the following instructions when applying for UL approval for machinery which includes one of these GP units.

- GP conforms as a component for the following standards:

UL 1950 (+ D3), Second Edition, dated February 26, 1993 (Standard for Safety of Information Technology Equipment, including Electrical Business Equipment)

CAN/CSA-C22.2 No. 950-M89 (+D3) (Standard for Safety of Information Technology Equipment, including Electrical Business Equipment)

The D3 deviations are: SC1.3.4, SC1.3.8, SC2.1, SC2.9, and SC5.3.

These deviations will lose effect on March 15, 2000.

GP270-LG31-24V (UL Registration Model: 0680028-03) Class III Equipment

GP270-SC31-24V (UL Registration Model: 0680028-04) Class III Equipment

- Machinery with a GP mounted in it requires UL inspection for the combination of the GP and the machinery.
- GP mounted machinery will also be treated as having the D3 deviations.
- Please be sure the GP's rear cover is protected by machinery with a FIRE ENCLOSURE. The GP's rear plastic case does not have the features for a flame protective enclosure required by the UL standard. The FLAMMABILITY RATING for the rear plastic case is 94V-0.
- The electric power must be supplied by ELV circuit that complies with Sub-clause 1.3.8 in the UL1950 Standard, or from a limited power source which fulfills conditions C1 and 2.11.
  1. A power supply with DOUBLE INSULATION or REINFORCED secondary circuits (for the UL recognized power supply (QQGQ2), the Output Category (OC) must be SELV). However, for a power supply with Spacing (SP) approved by the UL 1950, use a supply approve without the D3 deviations.
  2. With any load and a combination of single failure, the power supply must have power output under 250VA, and output current under 41A.
  3. The electric power must be supplied through a UL approved fuse (JDYX) . However, the fuse must be rated 1A, and it must break when the current exceeds 210% of the rating for over 120 seconds.
- If the GP is mounted to cool itself naturally, please mount it onto a vertical panel. Also, ensure that GP unit is mounted at least 100mm away from adjacent structures and other parts. If these conditions are not met, the heat generated by internal components may cause a failure to meet the UL standard requirements.

# CE Marking Notes

---

The GP270-LG21-24VP and GP270-SC21-24VP models are CE marked products that conform to EMC Directive, EN55022 Class A and EN50082-2.

## What is IP65f?

---

This unit's protection rating of IP65f is actually a composite code, consisting of the internationally recognized British "Ingress Protection" standard (BS EN 60529:1992) - "IP65", and the standard developed by the Japanese Electronics Manufacturer's Association (JEM) - "f". This code is used in this manual to identify a given product's degree of structural resistance to a variety of environmental elements and thus, prevent problems or accidents related to the inappropriate use of a product.

The individual meaning of each character of this code is explained below. This code indicates the degree of ingress protection provided from the front face of the GP, and assumes that the GP is securely mounted into a metal panel.

<b>IP</b>	<b>6</b>	<b>5</b>	<b>f</b>
(1)	(2)	(3)	(4)

- (1) Designates the type of protection provided.
- (2) Indicates the degree of protection provided to the human body by the unit, and the degree of protection provided by the unit's front face from particles/dust intrusion into the interior of the unit.

Here, "6" indicates that the unit is completely protected from dust intrusion.

- (3) Indicates the degree of protection provided by the unit's front face from water intrusion into the interior of the unit.

Here, "5" indicates that the unit is protected from water intrusion from a direct water jet.

- (4) Indicates the degree of protection provided by the unit's front face from oil particle intrusion into the interior of the unit.

Here, "f" indicates that the unit is completely protected from oil intrusion via either oil particles or oil splashes from any direction (to the front panel).



# Package Contents

---

The GP's packing box contains the items listed below. Please check to confirm that all items shown below have been included.

- **GP Unit**  
(GP270-LG11, GP270-SC11,  
GP270-LG21-24VP, GP270-SC21-24VP,  
GP2710-LG31-24V,GP270-SC31-24V)

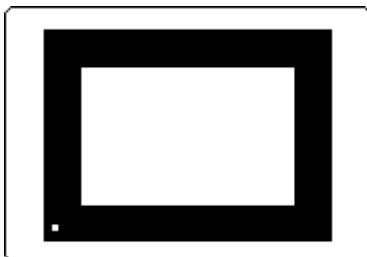

- **Installation Guide (1)**

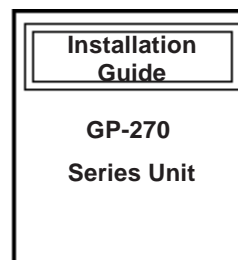

- **Installation Fasteners (\*\*/set)**

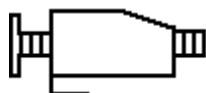

This unit has been carefully packed, with special attention to quality. However, should you find anything damaged or missing, please contact your local GP distributor immediately for prompt service.

## Separately Sold Manual

---

This manual (GP-270 Series Users Manual) is sold separately.

- **GP-270 Series Users Manual**

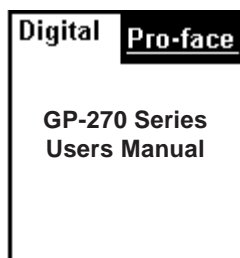

# Documentation Conventions

---

The list below describes the documentation conventions used in this manual.



Warns a situation that could seriously injure a person or lead to death if the GP is used in a wrong way or the warning is ignored.



Explains a situation that could injure a person or damage materials if the GP is used in a wrong way, or the warning is ignored.



Explains a situation that requires a moderate amount of caution.

PLC

Programmable Logic Controller

\*1

A reference point. Describes the word or phrase marked by the asterisk (\*) and the corresponding number.



Indicates a word or phrase that may require additional explanation.



Reference pages on related topics.

**n:1**

n:1 (multi-link) connection setup.

# Chapter 1

## Introduction

1. Before Operating GP
2. System Structure
3. Optional Equipment

### 1.1 Before Operating GP

Follow these steps before operating the GP unit.

---

- 1 Preparation**

Before using the GP, arrange the hardware and check the specifications, wiring, and installation.

**REFERENCE →** Chapter 2, "Specifications", and Chapter 3, "Installation and Wiring".
- 2 Screen Design**

Draw a Screen and design a Tag layout, using the Screen layout sheet and Tag list provided in your manual.
- 3 Select PLC**

Using your screen design software, select the PLC host that is connected to the GP unit.

**REFERENCE →** *Software Operation Manual*.
- 4 Create Screen/ Run Screen Setup**

Setup the screen and tags in your screen editing software, while referring to your screen design.

**REFERENCE →** *Software Operation Manual* and *Tag Reference Manual*.
- 5 Screen Data Transfer**

Transfer the data from the Screen design software on your PC to the GP unit using the Downloading Cable (included w/ the screen design software).

**REFERENCE →** *Software Operation Manual*.
- 6 Initialize**

Following the specifications of the PLC host in use, initialize the setup of the GP unit.

**REFERENCE →** Chapter 4, "Initialize", and the *PLC Connection Manual*.

**7 Run**

Link the GP with the PLC host using the Connection Cable (different cables may be necessary for different hosts), then run the System.



**REFERENCE →** *PLC Connection Manual*.

**1.2 System Structure**

The diagram on the following page illustrates the peripheral equipment of the GP unit.

**Legend**

GP Interface	PLC Interface	PC Interface
① Tool Connector	③ RS-232C Port	⑥ Printer Interface
② Serial Interface	④ RS-422 Port	
	⑤ Program Port	

 Screen Editing Environment  
 GP Operating Environment

Optional Parts

Optional items sold separately.

Maintenance Parts

These items are originally included with or in the package of GP unit. They can also be purchased separately for replacement.

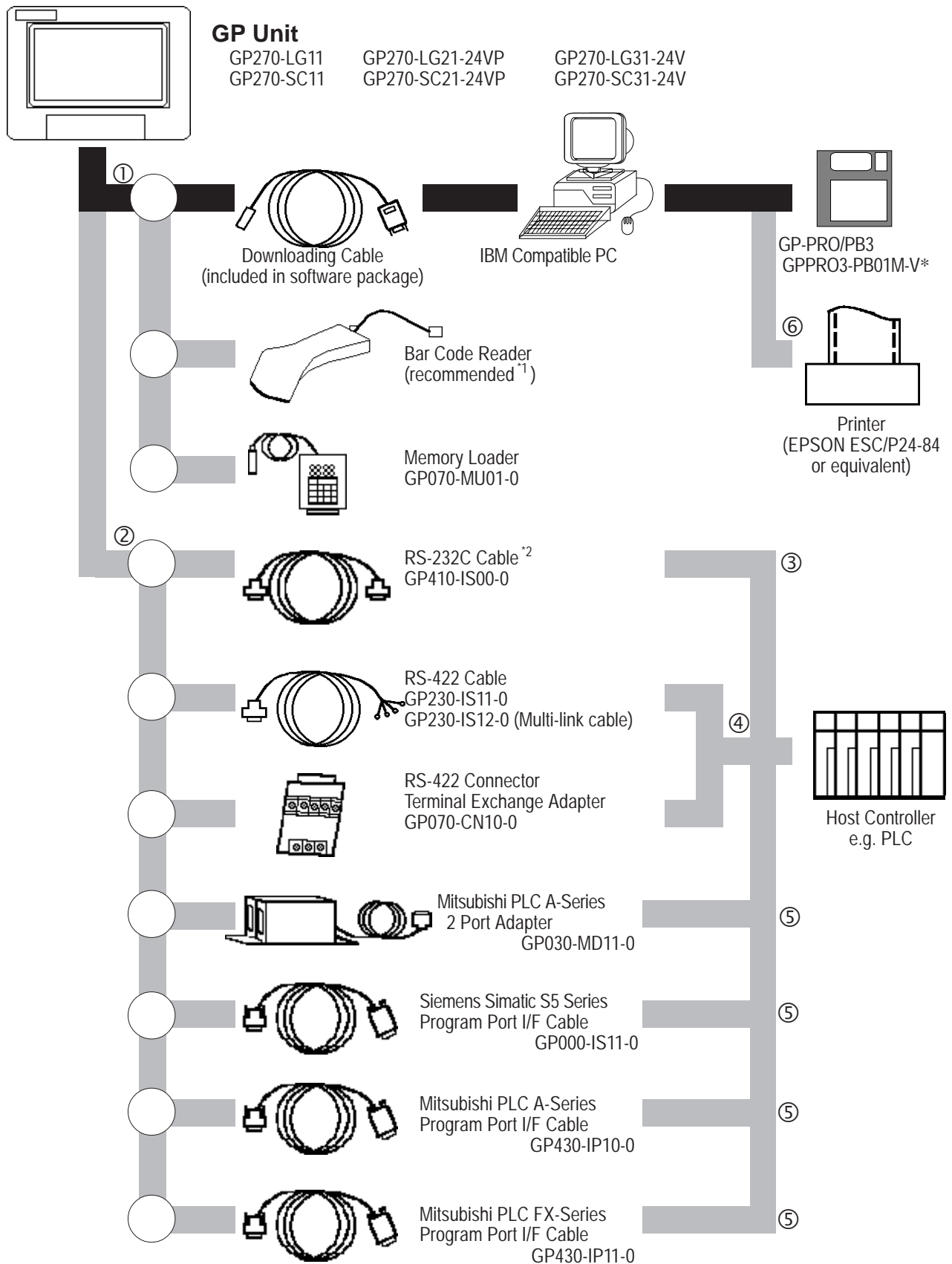

# Introduction



**Optional Item**

	Cover Sheet GP270-COVER-20P
---	--------------------------------

**Maintenance Items**

	GP-270 Backlight Bulbs GP270-BL00-MS
	GP-70 Series Installation Brackets GP070-AT00-MS
	Rubber Gasket GP270-WP10-MS

\*1 Usable PC model may be limited.

**REFERENCE →** *Software Operation Manual.*

\*2

Aimex Corporation	OPT Electronics			Tohken	
BR-331 PC2 (Pen type)	Reading Width	Touch Scanner Type	Keyboard Connection Type	Reading Width	Touch Scanner Type
	60mm	OPT-1125-WL 98	OPT-1125-WD 98	65mm	TCD-5510M
	80mm	OPT-5125-WL 98	OPT-5125-WD 98	82mm	TCD-5510L
	100mm	LT-2125-WL 98	LT-2125-WD 98	105mm	TCD-5510W

\*3 According to the PLC type, some connections cannot be made.

**REFERENCE →** *PLC Connection Manual.*

## Introduction

### 1.3 Optional Equipment

All optional equipment listed below are products of Digital Electronics Corp.

	ITEM	DESCRIPTION
Screen Editing Tool	GP-PRO/PB III GP screen editing software (GPPRO3-PB01M-V*)	GP-PRO/PB III PC based Screen design Software to run on GP-470/570/270 Series. Downloading Cable Connects your PC to the GP and transfers screen data between the two.
Serial Interface	RS-232C Cable <sup>*1</sup> (GP410-IS00-O)	I/F Cable to connect the GP unit with the PLC.
	RS-422 Cable (GP230-IS11-O)	
	Multi-link Cable (GP230-IS12-O)	Runs multi-link (n:1) SIO between each PLC type and GP series. RS-422 interface cable.
	RS-422 Terminal Connector Adapter (GP070-CN10-O)	Adapter for changing the terminal output from a serial interface to RS-422 I/F.
	Siemens Simatic Series Programming Port I/F Connection Cable (GP000-IS11-O)	TTY converter cable for Siemens Simatic S5 Series PLCs. You would not be able to use a program console at the same time.
	Mitsubishi A Series Programming Port I/F cable (GP430-IP10-O)	Connects directly to Mitsubishi's FX Series I/F Programming Console, making the conversion link unnecessary. However, cannot use a program console at the same time.
	Mitsubishi PLC FX Series Programming Port I/F Cable (GP430-IP11-O)	
Mitsubishi PLC A Series 2 Port Adapter (GP030-MD11-O)	An interface unit that enables use of the GP Series and Mitsubishi A series equipment in the same location.	

\*1 According to your PLC type, some connections are not possible. **REFERENCE →** *PLC Connection Manual*.

	<b>ITEM</b>	<b>DESCRIPTION</b>
Option Part	Cover Sheet GP-270 (GP270-COVER-20P)	Disposable GP screen protection from dust and other elements. The GP can be used with the Cover Sheet still attached to the GP screen. (20/set)
Maintenance Parts	GP-270 Backlight Bulbs (GP270-BL00-MS)	Replacement Backlight bulbs.
	GP-70 Series Installation Brackets (GP070-AT00-MS)	Metal installation brackets for GP-470/570/270 Series
	Rubber Gasket GP-270 Series (GP270-WP10-MS)	Rubber gasket for installing the GP. Same as in the original GP equipment package.
Tool Connector	Memory Loader (GP070-MU01-O)	Runs a high speed data copy from one GP to another (System program and Screen data).



# Chapter 2

## Specifications

1. General Specifications
2. Function and Performance
3. Inter face Specifications
4. Names and Functions of GP Parts
5. Graphic Panel Dimensions

### 2.1 General Specifications

#### 1. Electrical Specifications

	GP270-LG**	GP270-SC**
<b>Input Voltage</b>	DC24V	
<b>Rated Voltage</b>	DC20.4V to DC27.6V	
<b>Power Consumption</b>	12W or less	
<b>Allowable Voltage Drop</b>	2ms or less	
<b>Voltage Endurance</b>	AC1000V 10mA for 1 minute (between charging and FG terminals)	
<b>Insulation Resistance</b>	20MΩ or higher at DC500V (between charging and FG terminals)	

#### 2. Structural Specifications

<b>Ratings</b> (For front face of installed unit)	Equivalent to IP65f (JEM1030) and NEMA #250 TYPE 4X/12
<b>External Dimensions</b> (mm)	172mm (W) x 127mm (H) x 58mm (D) (main unit only)
<b>Weight</b>	800g or less (GP unit only)
<b>Cooling Method</b>	Natural air circulation

\*1 See note on following page.

(From previous page)

*\*1 The front face of the GP unit, installed in a solid panel, has been tested using conditions equivalent to the standard shown in the specification . Even though the GP unit's level of resistance is equivalent to the standard, oils that should have no effect on the GP can possibly harm the unit. This can occur in areas where either vaporized oils are present, or where low viscosity cutting oils are allowed to adhere to the unit for long periods of time. If the GP's front face protection sheet becomes peeled off, these conditions can lead to the ingress of oil into the GP and separate protection measures are suggested. Also, if non-approved oils are present, it may cause deformation or corrosion of the front panel's plastic cover. Therefore, prior to installing the GP be sure to confirm the type of conditions that will be present in the GP's operating environment.*

*If the installation gasket is used for a long period of time, or if the unit and its gasket are removed from the panel, the original level of the protection cannot be guaranteed. To maintain the original protection level, you need to replace the installation gasket regularly.*

### 3. Environmental Specifications

<b>Ambient Operating Temperature</b>	0°C to 50°C
<b>Storage Temperature</b>	-20°C to 60°C
<b>Ambient Humidity</b>	20%RH to 85%RH
<b>Atmosphere</b>	Free of conductive dust and corrosive gasses
<b>Vibration Resistance</b>	10Hz to 25Hz (2G in X, Y, Z directions for 30min.)
<b>Noise Immunity (via noise simulator)</b>	Noise Voltage: 1000Vp-p
	Pulse Duration: 1msec.
	Arise Time: 1ns
<b>Grounding</b>	100Ω or less grounding resistance <sup>*1</sup>

*\*1 Be sure to use your country's applicable standard.*

# Specifications

## 2.2 Function and Performance

### 1. Display Functions

	<b>GP270-LG**</b>	<b>GP270-SC**</b>
<b>Display Media</b>	Monochrome LCD	STN Color LCD
<b>Display Color</b>	White, Black	8 colors (white, red, blue, green, yellow, magenta, cyan, black) Tiling patterns make blends of colors possible
<b>Back light</b>	CFL (under normal temperatures and humidity, lifespan = 20,000 hours)	
<b>Resolution</b>	320 × 240 pixels	
<b>Display Area</b>	96W × 72H (mm)	
<b>Attributes</b>	Blink/ Reverse Video	
<b>Contrast Adjustment</b>	The Touch Panel has 8 levels of contrast adjustments available	
<b>Characters</b>	Korean: (KSC5601-1992 codes) Hangul fonts (including Kanji)	
	Chinese: (GB2321-80 codes) simplified Chinese fonts	
	Taiwanese: (Big 5 codes) traditional Chinese fonts	
	ASCII: (Code Page850) Alphanumeric (including European fonts)	
	Japan: ANK 158 type, Kanji:6349 (includes non-Kanji:453, and Standard JIS Type 1 and Type 2)	
<b>Char. Disp. #</b>	8x8 dot font: 40 Char. per row, 30 rows 8x16 dot font: 40 Char. per row, 15 rows 16x16 dot font: 20 Char. per row, 15 rows	
<b>Character Size</b>	Height and width can be expanded by 2, 4, or 8.	

## 2. Screen Memory

---

	GP270-LG**	GP270-SC**
<b>Internal Memory</b>	FLASH EPROM 256 Kbytes (Up to 160 screens w/ a standard screen size of 1.6 Kbytes)	

## 3. Touch Panel / Clock Accuracy

---

	GP270-LG**	GP270-SC**
<b>Touch Panel</b>	16 × 12 keys/ screen (1 or 2 point touch)	
<b>Clock Accuracy</b>	+/- 40 seconds/ month (at room temperature)	

## 4. External Interface

---

	GP270-LG**	GP270-SC**
<b>Serial Interface</b>	Asynchronous Transmission Method: RS-232C/RS-422 Data Length: 7 or 8 bits Stop Bit: 1 or 2 bits Parity: None, Odd or Even Data Transmission Rate: 2400~38400bps	
<b>Tool Connector</b>	RS-232C Asynchronous Transmission TTL level non-procedure command interface (During Development) use the I/F to download Screen design (During RUN mode) use with the BarCode Reader I/F	

## 2.3 Interface Specifications

### 1. Serial Interface

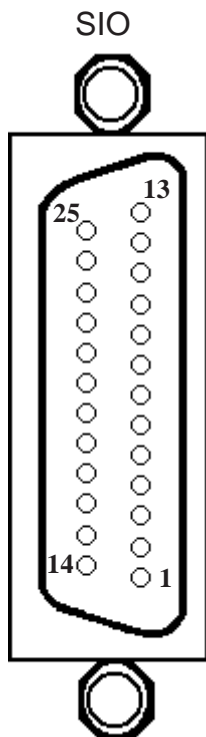

Pin #	Signal Name	Condition	Pin #	Signal Name	Condition
1	FG	Frame ground	14	VCC	5V output 0.25A
2	SD	Send data (RS-232C)	15	SDB	Send data B (RS-422)
3	RD	Receive data (RS-232C)	16	RDB	Receive data B (RS-422)
4	RS	Request send (RS-232C)	17	NC	No connection
5	CS	Clear send (RS-232C)	18	CSB	Clear send B (RS-422)
6	NC	No connection	19	ERB	Enable receive B (RS-422)
7	GND	System ground	20	ER	Enable receive (RS-232C)
8	CD	Carrier detect (RS-232C)	21	CSA	Clear send A (RS-422)
9	TRMX	Termination (RS-232C)	22	ERA	Enable receive A (RS-422)
10	RDA	Receive data A (RS-422)	23	RESERVED	Reserved for future use
11	SDA	Send data A (RS-422)	24	NC	No connection
12	NC	No connection	25	RESERVED	Reserved for future use
13	NC	No connection			

Recommended Connector: Dsub25pin plug XM2A-2501 <made by OMRON Corp.>

Recommended Cover : Dsub25pin Cover XM2S-2511 <made by OMRON Corp.>

Dsub25pin plug XM2A-2501 <made by OMRON Corp.>

Recommended Cable : CO-MA-VV-SB5P×28AWG <made by HITACHI Cable Ltd.>

**REFERENCE →** *PLC Connection Manual* to determine your PLC's connection points.



**Be sure to connect your GP's SG/GND (Signal Ground) Terminal to the other unit's signal ground terminal.**



When creating your own cable, follow the instructions listed below concerning each connection type.

#### RS-422

The following pairs of pin #'s must be connected to each other.

..... #18 (CSB) <—> #19 (ERB)

..... #21 (CSA) <—> #22 (ERA)

- When connecting the RS-422 cable and the #9 (TRMX) and #10 (RDA) points, a termination resistance of 100Ω is added between RDA and RDB.

- When making a cable for the Memory Link format, be sure to select a 4-line System.

#### RS-232C

- Do not use the following pins:

9 (TRMX), 10 (RDA), 11 (SDA), 15 (SDB), 16 (RDB), 18 (CSB), 19 (ERB), 21 (CSA), 22 (ERA).

## GP-270 Serial Interface Connections

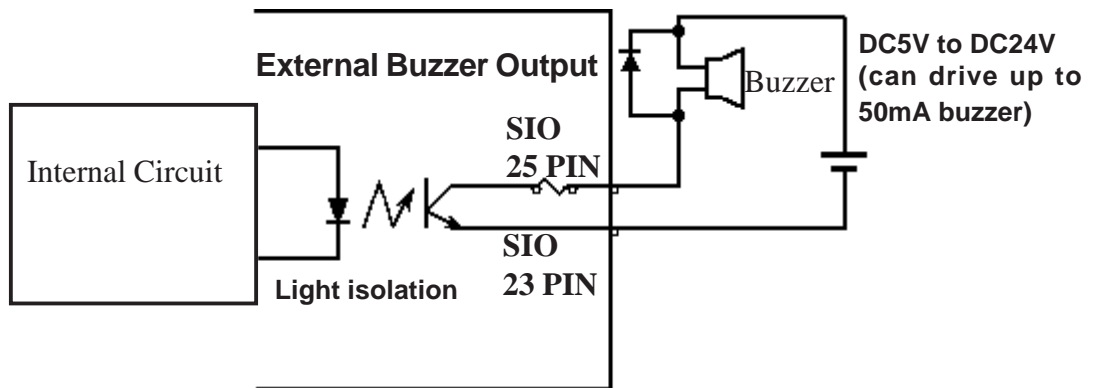

## 2.4 Names and Functions of GP Parts

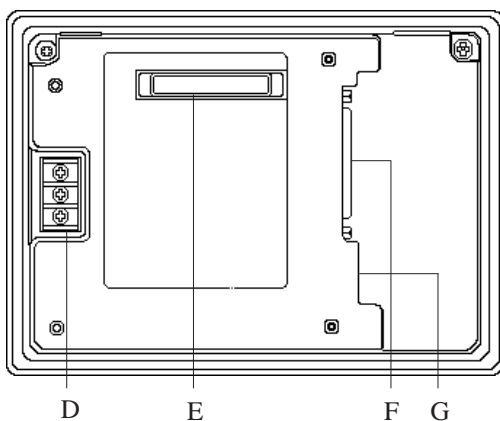
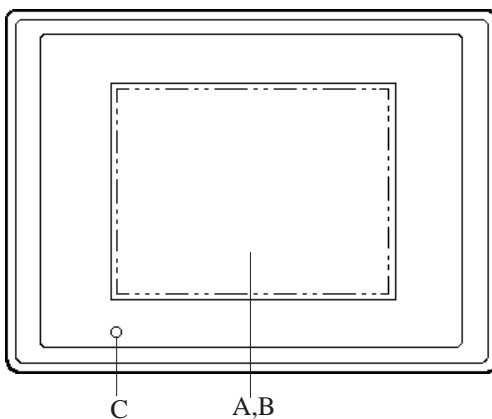

- A: Display Type.  
The GP monitor screen displays the screen setup and corresponding PLC host data.  
GP270-LG\*\* Monochrome LCD  
GP270-SC\*\* STN type Color LCD
- B: Touch Panel  
Runs any screen change operations and sends data to the PLC.
- C: Power Lamp  
Lights up when the power is turned On. (Green LED)
- D: Power Input Terminal Block  
Power cable connection.
- E: Extension Interface  
This I/F will be used in future versions.
- F: Serial Interface  
Connect the RS-232C and RS-422 (Serial) interface to the PLC host.
- G: Tool Connector  
The Transfer cable and Bar Code reader connect here.

# Specifications

## 2.5 Graphic Panel Dimensions

### 1. GP-270 Series External Dimensions

Unit: mm

Top View

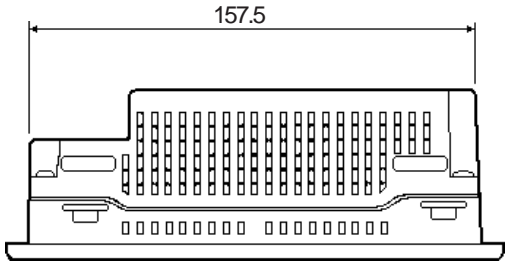

Front View

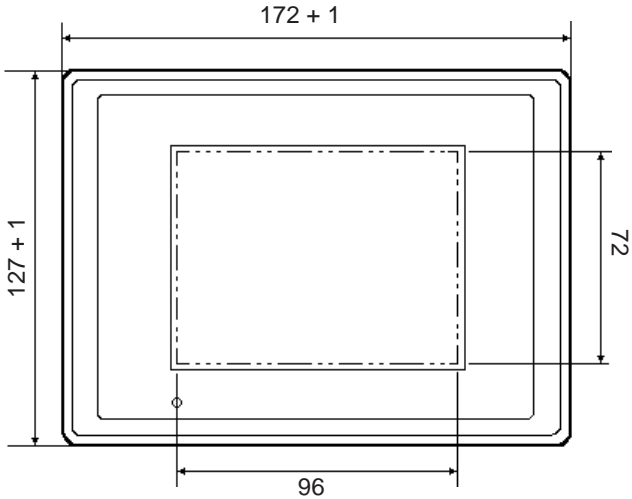

Side View

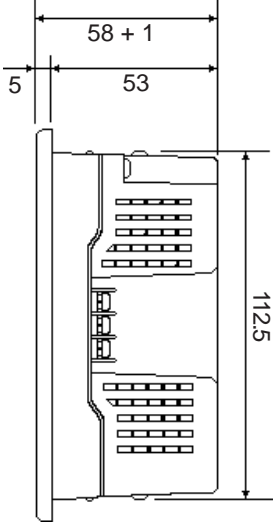

Rear View

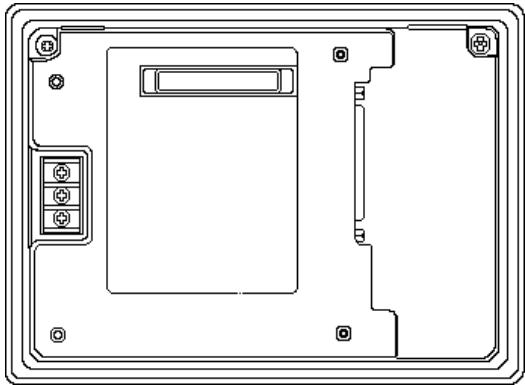

## 2. Installation Fasteners

---

Units: mm

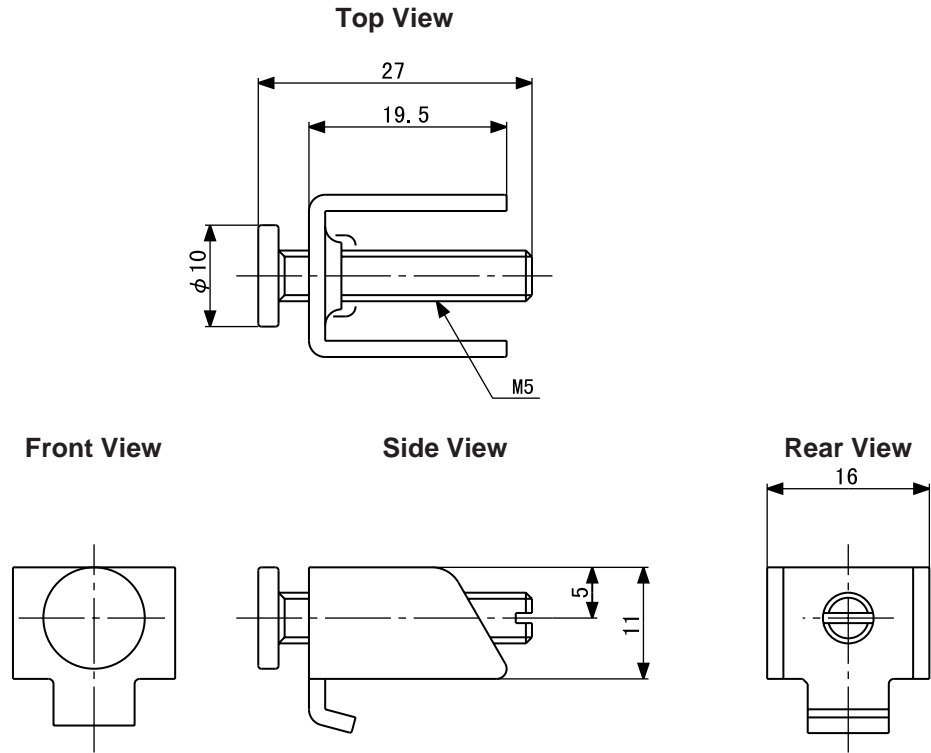



# Specifications

## 3. GP Installation Dimensions

---

Unit: mm

Mounting Hole for Installation

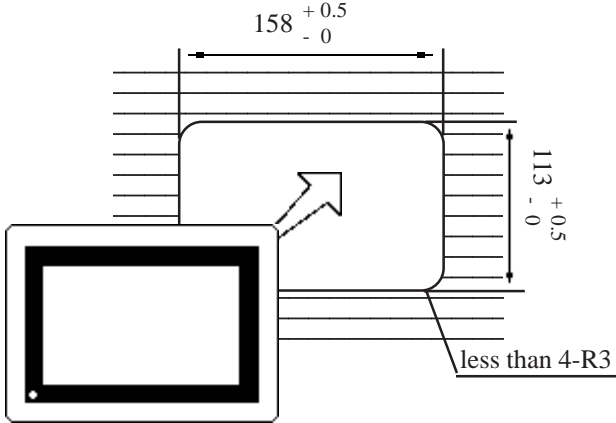



## Chapter 3

# Installation and Wiring

1. Installation
2. Wiring
3. Printer Connection
4. Tool Connection

### 3.1 Installation

When installing the GP panel, be sure to follow the steps listed below.



**Before installing the GP into a cabinet or panel, check that the moisture resistant gasket is securely attached to the unit.**

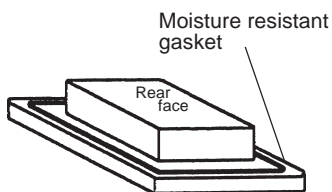

It is strongly recommended that you use the gasket since it absorbs vibration in addition to repelling water.

Place the GP on a level surface with the display panel facing downward. Check that the GP's moisture resistant gasket is seated securely into the gasket's groove, which runs around the perimeter of the panel's frame. For details about installing the gasket, refer to

**Reference** 7.1.2 *Moisture Resistant Gasket Replacement*

#### ■ Creating a Panel Cut Out

Create the correct sized opening required to install the GP, using the installation dimensions given.

**Reference** 2.5.3 *“GP Panel Cut Out Dimensions”*

The moisture resistant gasket, installation brackets and attachment screws are all required when installing the GP.

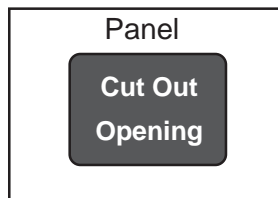

- It is important that the panel or cabinet's surface is flat, in good condition and has no jagged edges.
- Panel thickness should be from 1.6mm to 5.0mm.

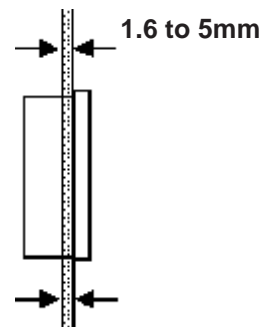

## Installation and Wiring



- For easier maintenance and operation, plus better ventilation, ensure the GP unit is mounted at least 100 mm away from adjacent structures and other parts.

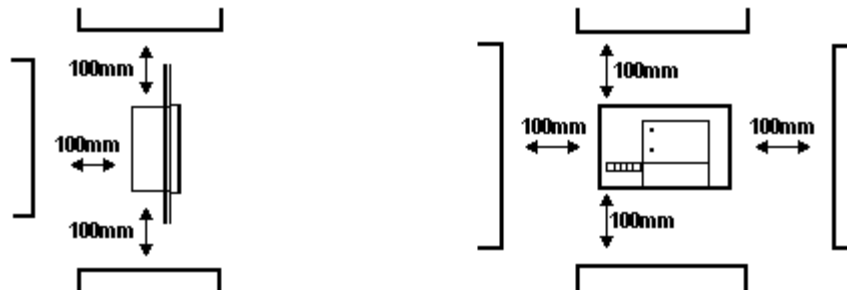

- The GP uses ventilation in its outer shell to naturally cool itself. When installing the unit horizontally or sideways, use a forced air cooling system (i.e. a fan) or lower the surrounding temperature to avoid overheating.

### Vertical Installation

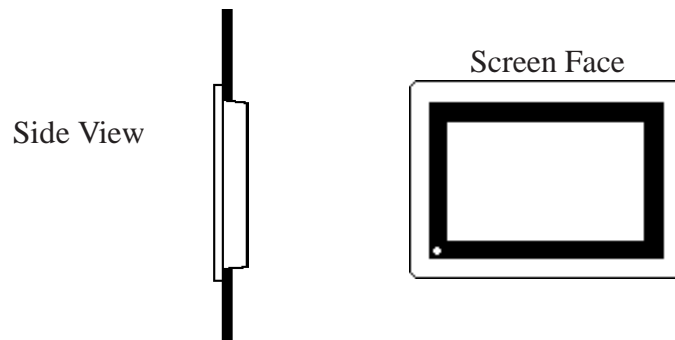

### Horizontal Installation

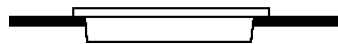

### Sideways Installation

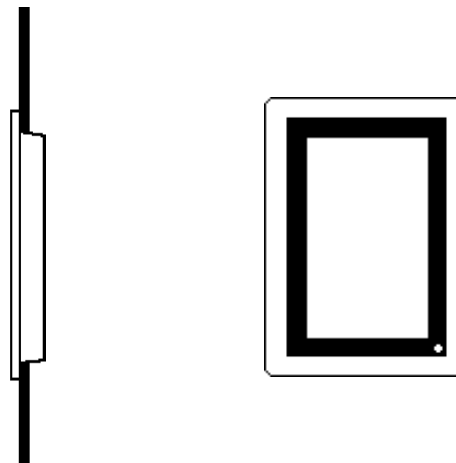

## Installation and Wiring

- When installing sideways, place the GP so that the Power Terminal Block points upwards.
- Ensure heat from other equipment does not cause extra heating pressure on the GP.
- Do not use GP-270 Series in an environment that exceeds 50° C.
- Ensure that this unit is located as far away as possible from electromagnetic circuits, non-fuse type breakers, and other equipment that can cause arcing.
- When installing the GP unit, with natural air circulation cooling system, onto a slanted panel, the panel slope should not incline more than 30°.

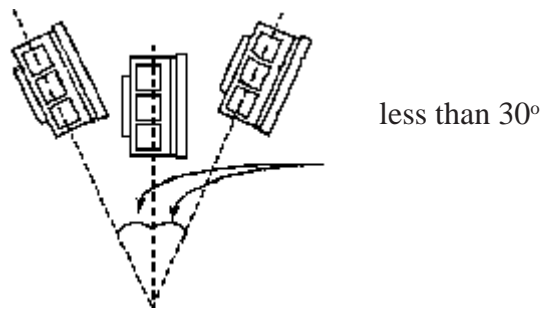

Install the unit from the front of the panel opening.

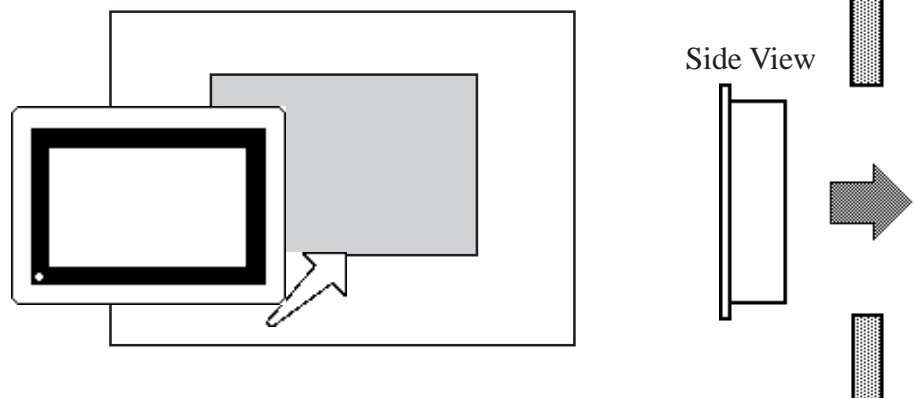

Secure the Installation brackets from the backside of the panel.

There are 4 insertion slots on the top and bottom of the GP, where the metal installation brackets hook on.

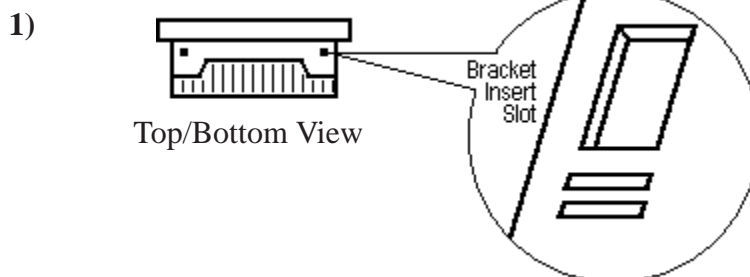

## Installation and Wiring

### 2) Installation Bracket

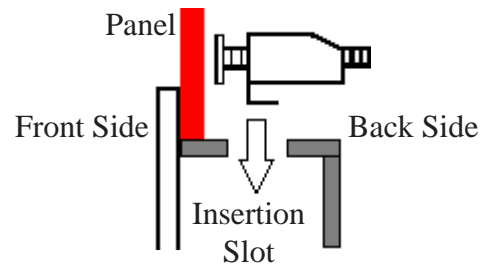

3) After inserting the brackets into the appropriate slots, carefully force the bracket to the back of the GP.

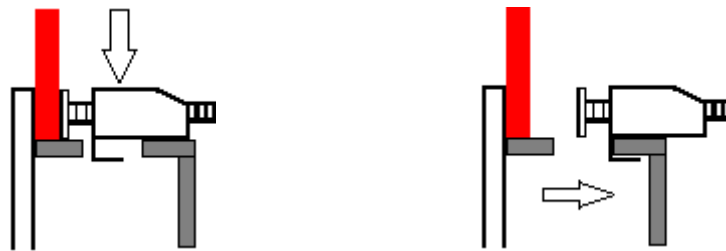

Use a screw driver and tighten the screw from the back to hold the GP unit in place. No more than 0.5 to 0.6N•m is required to tighten the screw.

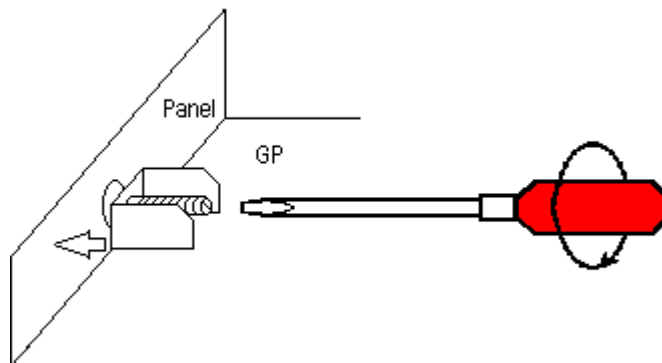

Using too much force may damage the GP unit.

# Installation and Wiring

## 3.2 Wiring

### 1. Power Cable Connection



- To avoid electric shocks, be sure the Power Cord is unplugged from the main power outlet before connecting the power terminals to the GP's terminal block.
- GP-270 Series units can only use DC24V input. If you supply power other than DC24V, you will damage both the power supply and the GP unit.
- There is no power switch on the GP unit, so please use a breaker switch.



When the FG terminal is connected, be sure the wire is grounded. Not grounding the GP unit will result in excess noise.



- Wherever possible, use thick wires (max 2mm<sup>2</sup>) for power terminals, and provide an extra twist to the wire during connection.
- Please use Ring Terminals with the size described below.
- To avoid a short among the ring terminals when the screws get loosen, please use ring terminals with a sleeve.

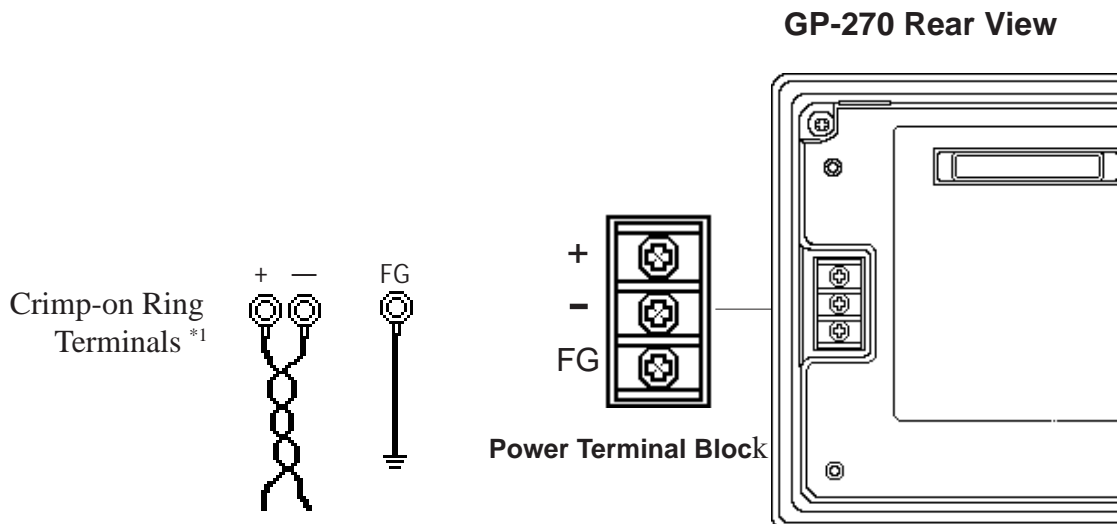
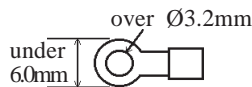

Connect the GP power cord terminals as follows.

- 1) Check to make sure the Power is Off.
- 2) Remove the Terminal Block's protective plastic cover.

\*1 Ring Terminals: V2-S3 equivalent (made by JST)

- 3) Disconnect the screws from the 3 terminals, align the power wire terminal ends and re-attach the screws. (Check each wire to make sure the connections is secure)
- 4) Replace the plastic Terminal Block cover.

## 2. Precaution: Grounding

---

(a) Exclusive Grounding (BEST)

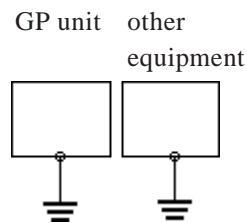

- Connect the GP's FG terminal to an exclusive ground. [diagram (a)]. Be sure there is a grounding resistance of  $100\Omega$  or less, or your country's applicable standard.

(b) common grounding (OK)

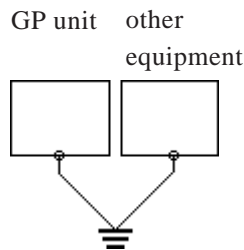

- If exclusive grounding is not possible, use a common connection point. [diagram (b)]

(c) common grounding (BAD)

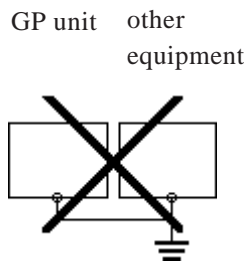

- The grounding wire should have a cross sectional area greater than  $2\text{mm}^2$ . Set the connection point as close to the GP unit, and make the wire as short, as possible. When using a long grounding wire, replace the thin wire with a thicker wire placed in a duct.
- If this equipment does not function properly when grounded, disconnect the ground wire from the FG terminal.

## 3. Precaution: Input/Output Signal Lines

---

- Input and output signal lines must be separated from the power control cables for operating circuits.
- If this is not possible, use a shielded cable and connect the shield to the frame of the GP unit.



## Installation and Wiring

### 3.3 Tool Connector

The Data Transfer Cable or a Bar Code Reader can be connected to the Tool Connector socket.

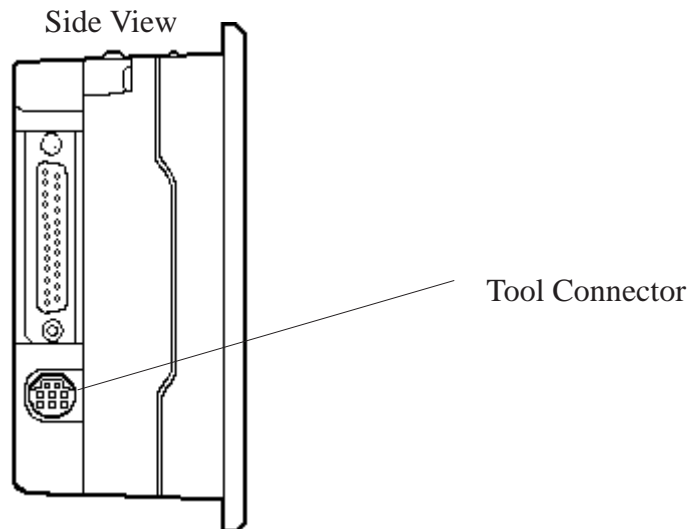

- When inserting or removing items from the Tool Connector socket, be sure the GP unit has been turned Off.
- When the Bar Code Reader uses a different power supply:
  - Turn the Bar Code Reader on before turning the GP unit on.
  - Turn the GP unit off before turning the Bar Code Reader off.



## Chapter 4

# OFFLINE Mode

1. Entering OFFLINE Mode
2. Main Menu
3. INITIALIZE—Standard Operations
4. SELF-DIAGNOSIS—Standard Operations
5. Transfer Screen Data

### 4.1 Entering OFFLINE Mode

The OFFLINE Mode refers to Initialize, Self-Diagnosis, and other setup areas contained in the GP. You will need to switch the GP unit to OFFLINE mode before viewing any of these areas.



OFFLINE mode is unavailable in a completely new GP until its System Data has been transferred from your PC to the GP, via the GP-PRO/PBIII for Windows software.

To INITIALIZE the setup or run SELF-DIAGNOSIS in the GP unit, you will need to change to OFFLINE mode. There are two ways to switch to OFFLINE mode: first, when turning the unit on, and second, by using Forced Reset.

#### 1. When Turning the Unit On

Press the top left corner of the GP screen within 10 seconds of switching the power On.

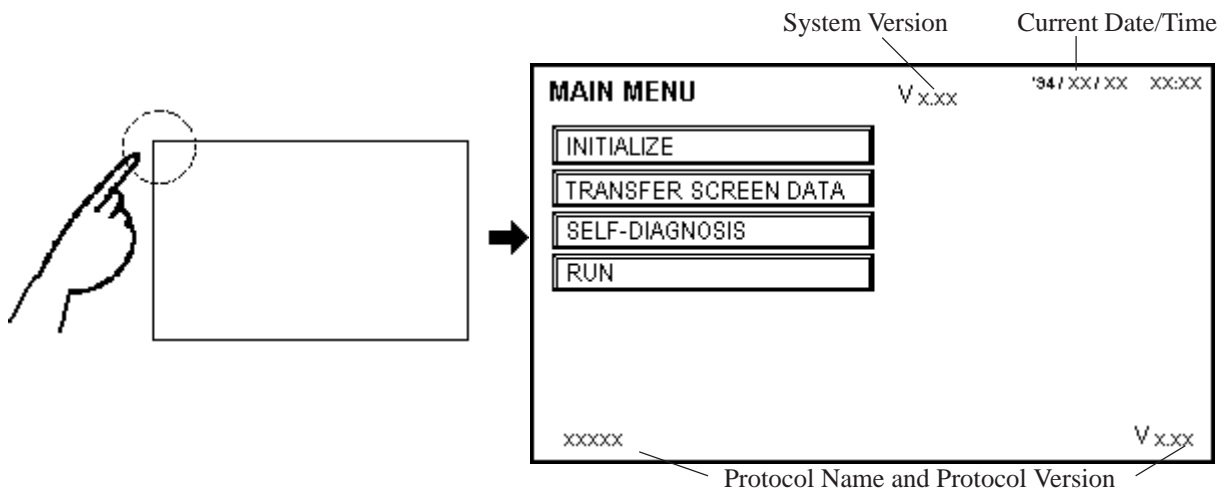

## 2. Enter From Force Reset

From the Force Reset screen, press the OFFLINE button.

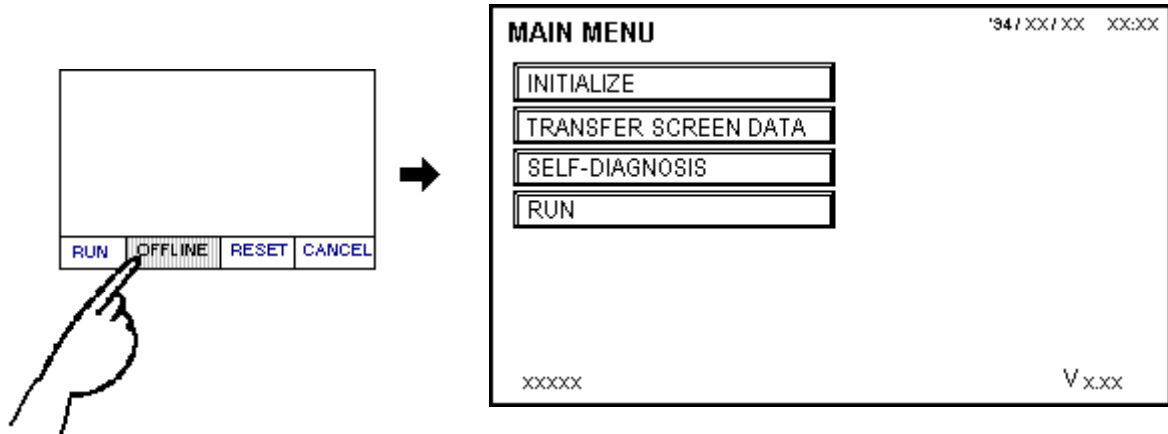

For more information about Force Reset [REFERENCE →](#) Chapter 5.4, "SET UP I/O".

If a Password has been set in INITIALIZE/ SET UP SYSTEM, before entering the OFFLINE mode, the following screen displays.

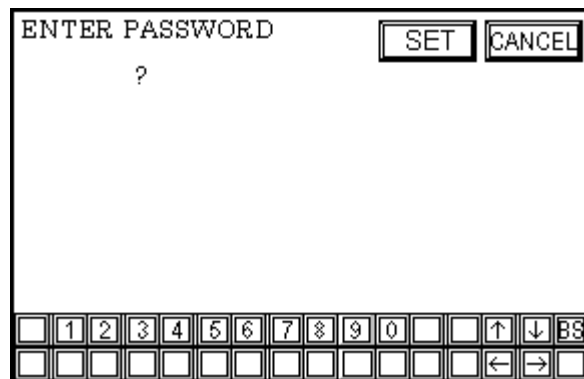

Enter the password, then press *Set* to enter OFFLINE mode.

For more about the *Password*, [REFERENCE →](#) Chapter 5.3, "SYSTEM SETUP".

For more information on the password input [REFERENCE →](#) Chapter 4.3, "INPUTTING NUMBERS".

## 4.2 Main Menu

The Main Menu includes the setup items listed below: INITIALIZE, SCREEN DATA TRANSFER, SELF-DIAGNOSIS, and RUN. Each menu item has different setups that must be set to match the corresponding PLC in order for the GP to communicate properly.

Entering the OFFLINE mode displays the screen illustrated below.

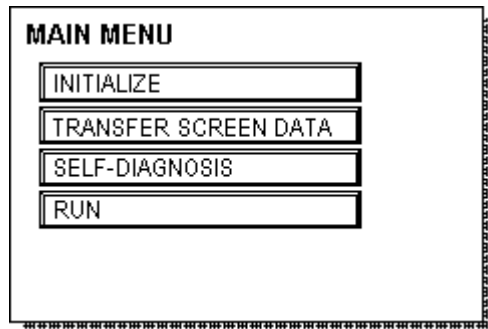

Select the menu item by pressing the title on the screen.

A short description of each Main Menu item follows.

### INITIALIZE

The setup items listed in this menu are necessary to run the GP unit.

### TRANSFER SCREEN DATA

Select to transfer screen data to and from the screen editing software.

### SELF-DIAGNOSIS

Checks to see if there are any problems with the GP System or Interface (I/F).

### RUN

Begins operations in the GP unit.

**REFERENCE →** For more information about INITIALIZE, refer to Chapter 5, "Initialize"; for more information about TRANSFER SCREEN DATA, refer to the *Software Operation Manual*; for more information about SELF-DIAGNOSIS and RUN, refer to Chapter 6, "Run and Errors".

**4.3 INITIALIZE—Standard Operations**

**Selecting A Menu**

- Press the menu title to setup.

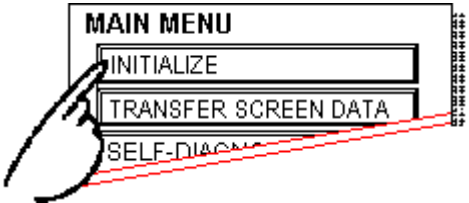

- Press the menu item you wish to setup.

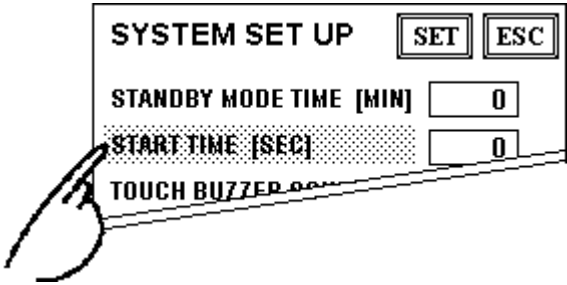

**Inputting Numbers**

- After selecting an input field by touching it, use the numeric touch keys that appear next to enter numeric values.

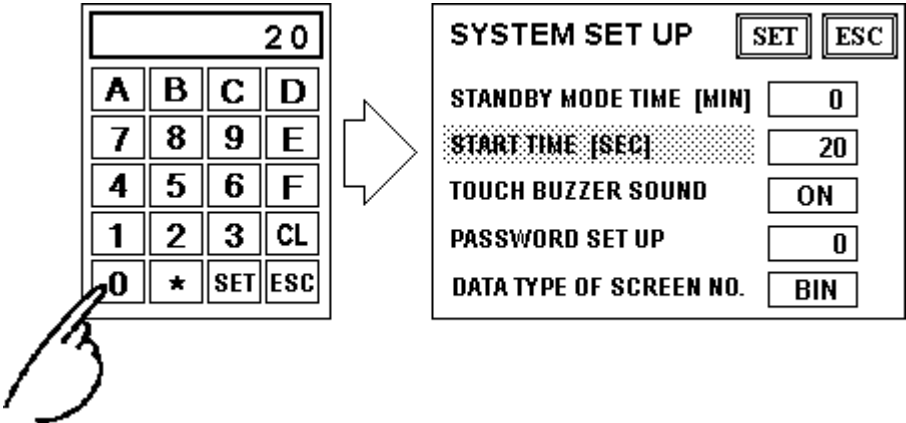

**Selecting Setup Conditions**

- After selecting the menu item, press the option you would like to setup. In this example, pressing the TOUCH BUZZER SOUND turns that option Off.

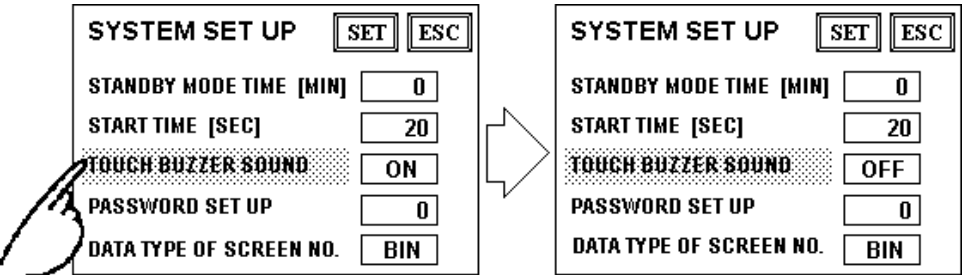

## OFFLINE Mode

### Ending Setup

To end setup, you would usually press the top-left button, SET.

If you wish to exit the screen without saving the changes, press the ESC button.

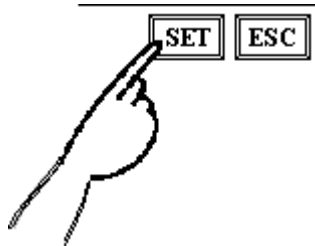

- Press the SET key to write the Setup conditions onto the Internal FEPRM, which may take some time, causing a delay in returning to the previous screen. Therefore, do not touch the screen until the previous menu display returns.
- Press the CANCEL key to *not write* the Setup conditions onto the Internal FEPRM and return to the previous menu.

### Return To Previous Screen

Press the title of the screen you would like to return to.

E.g. To return to the MAIN MENU from the SYSTEM ENVIRONMENT SETUP screen, simply press the MAIN MENU title.

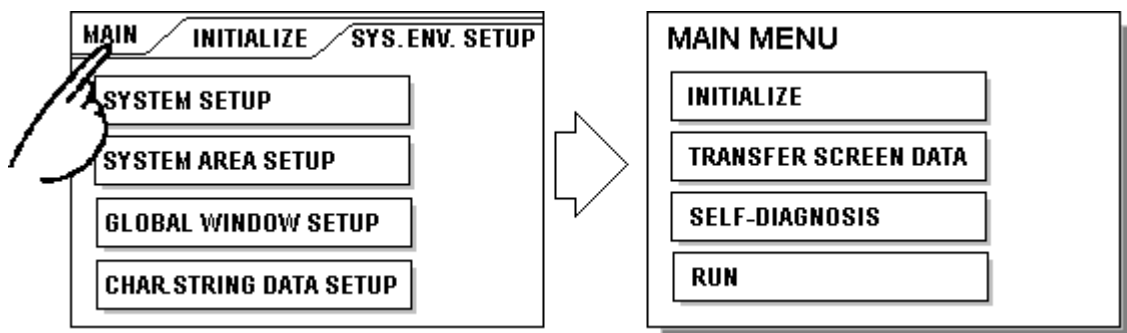

## 4.4

## SELF-DIAGNOSIS—Standard Operations

### Selecting A Menu

Press the title of the menu item to diagnose.

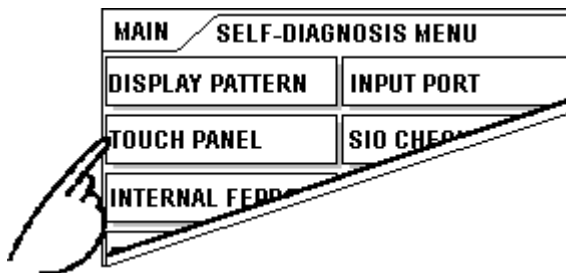

**SET, ESC Keys**

After selecting the SELF-DIAGNOSIS item, the **SET** and **ESC** keys appear at different times at the top of the screen.

E.g.

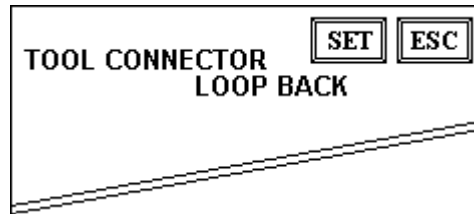

- SET Key

When this key is pressed, the Self-Diagnosis begins.

- ESC Key

When this key is pressed, the Self-Diagnosis command is cancelled, and you return to the Self-Diagnosis menu.

**After Check—To Return To SELF-DIAGNOSIS MENU**

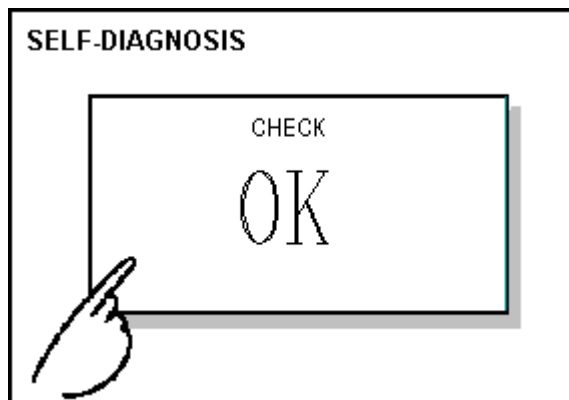

When OK displays, pressing once anywhere on the display screen returns you to the SELF-DIAGNOSIS MENU.

When an Error Message displays

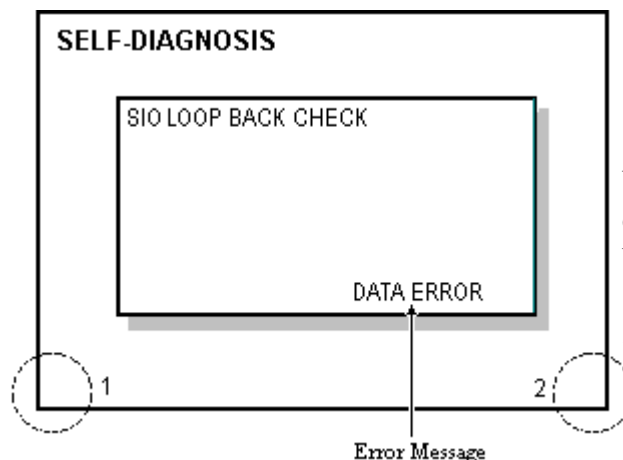

When an error message appears on the display screen, press the bottom two corners of the panel (1, 2) to return to the SELF-DIAGNOSIS MENU.



## OFFLINE Mode

### Return To Main Menu

Press the MAIN tab in the SELF-DIAGNOSIS menu to return to the MAIN MENU.

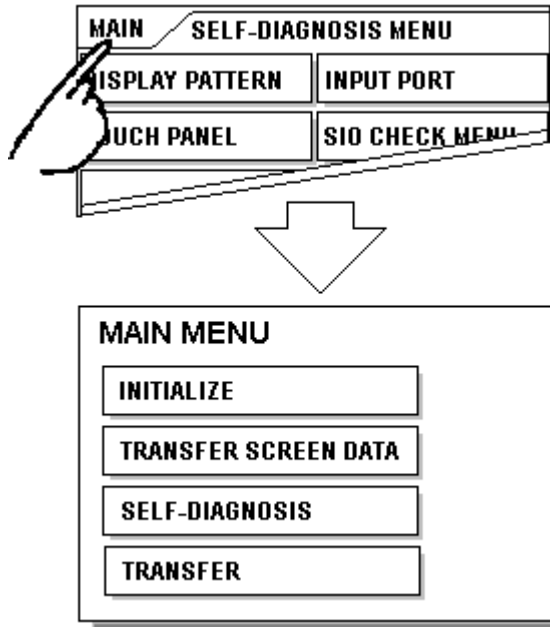

## 4.5 Transfer Screen Data

To transfer screen data from your PC to the GP, connect one end of the Data Transfer Cable to the GP-270 unit's Tool connector, and the other to your PC (Adaptor may be required), as shown below.

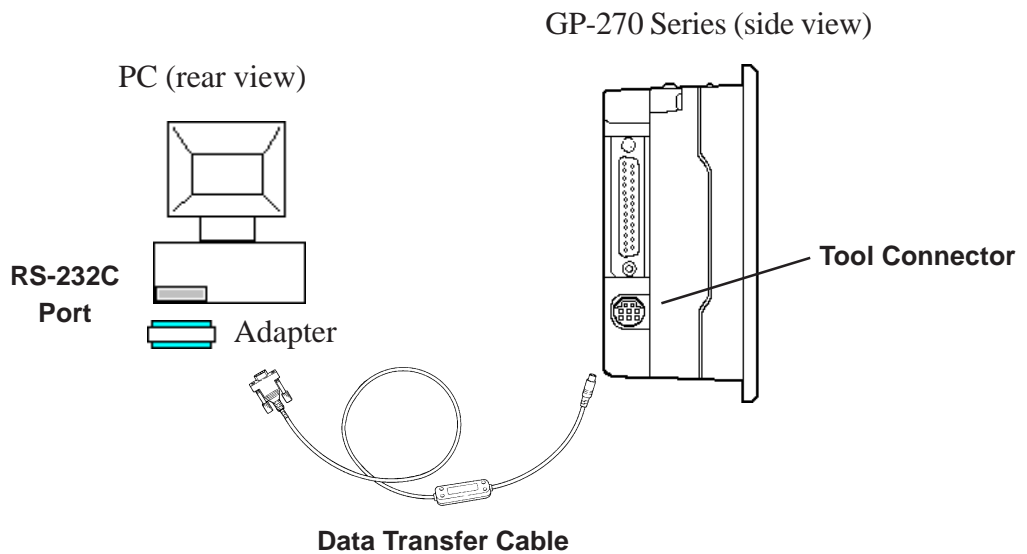



- Use an adapter to match the cable with your PC's Serial Port format.
- When using a serial mouse, use a different serial port for your data transfer.

Before transferring, set the GP to its TRANSFER SCREEN DATA mode. In your screen editing software, setup whether to send screen files to the GP, or to receive files from the GP.

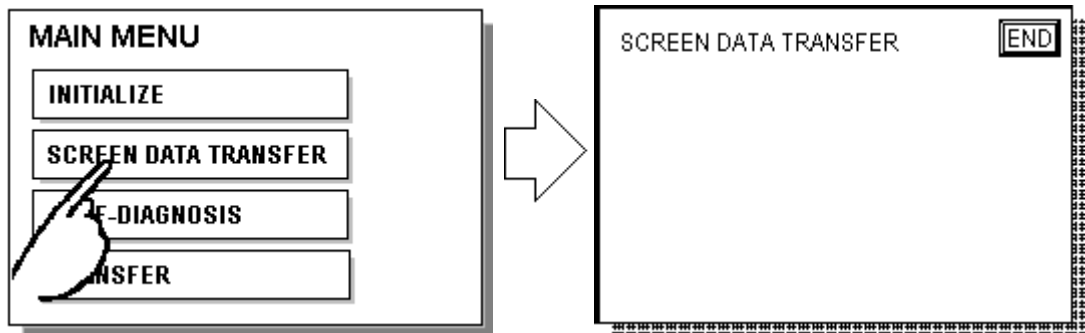

*GP-PRO/PBIII for Windows Operation Manual*

After setting up the GP, return to your screen GP, "Transferring, Please Wait". Once the message ends, transfer is complete.

Press the ESC key to return the GP to RUN mode. If a Screen File Number has been setup in GP's INITIALIZE setting, then that screen will display. If no screen number has been setup, then the GP will return to the MAIN MENU.



The GP can transfer screen data even while in RUN mode.

# Chapter 5

## Initialize

1. Initialize Screen
2. Initialize Items
3. SYSTEM ENVIRONMENT SETUP
4. SET UP I/O
5. PLC SETUP
6. INITIALIZE MEMORY
7. SET UP TIME
8. SET UP SCREEN

### 5.1 Initialize Screen

Before running the GP unit, various GP setups must be verified. These are listed under the INITIALIZE option in the MAIN MENU.

This chapter explains each of the Off-line mode's INITIALIZE items. However, there are 2 types of INITIALIZE setups, the **1:1** connection and the **n:1** (multi-link) connection\*1, and the setup information can differ for each.

The **n:1** mark appears on menu items concerned only with the n:1 multi-link connection. If there is no mark, the menu item is common to both 1:1 and n:1 connections.

**1:1** Process concerning 1 GP connected with 1 PLC.

**n:1** Process concerning multiple GP's connected with 1 PLC. The GP's successively pass a *token* (exclusive PLC interaction key) among themselves to communicate with the PLC.



If you transfer your screen editing software's System file (S0), the GP operates using the data contained therein. If the GP System file has been correctly setup and transferred, the INITIALIZE setups become unnecessary.

For more information about System file (S0) [REFERENCE →](#) *Software Operation Manual*, 1.1.2 "Screen Types"

---

\*1 PLC's that support the n:1 (multi-link) connection are limited.

[REFERENCE →](#) *GP-PRO/PB3 PLC Connection Manual*.

## 5.2 Initialize Items

The contents of the Initialize setup items listed below are explained in this chapter. To learn about screen operations and numeric input [REFERENCE →](#) Chapter 4, "Off-line Mode".

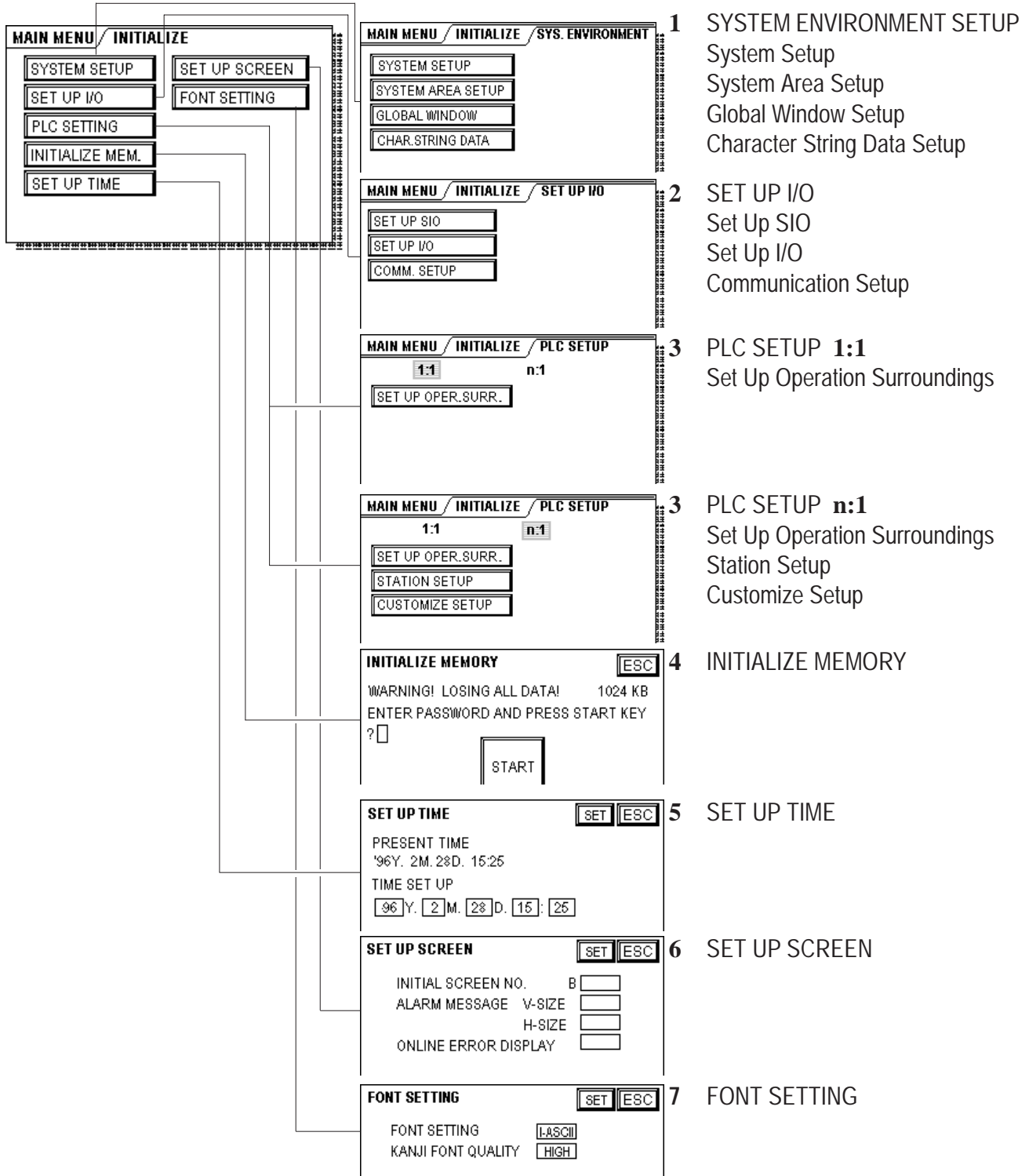

## 5.3 SYSTEM ENVIRONMENT SETUP

GP environment adjustments are made here. The SYSTEM ENVIRONMENT SETUP includes the SYSTEM SETUP, SYSTEM DATA AREA, GLOBAL WINDOW SETUP, and CHARACTER STRING DATA SETUP.

### 1. SYSTEM SETUP

SYSTEM SET UP		SET	ESC
STANDBY MODE TIME [MIN]		0	
START TIME [SEC]		20	
TOUCH BUZZER SOUND		ON	
PASSWORD SET UP		0	
DATA TYPE OF SCREEN NO.		BIN	

#### STAND-BY MODE TIME (0-255)

To protect the GP display screen, GP has been setup with a screen saver function that automatically erases the screen when no GP operations have occurred for the time entered here. A **0** entered in this field causes a normal display.

When SYSTEM DATA AREA's ( [REFERENCE →](#) *PLC Connection Manual*) SCREEN DISPLAY OFF<sup>\*1</sup> data is **0000h**, and the following operations are *not* performed on the screen for the number of minutes setup, the GP display erases.

- Change Screen
- Touch Screen
- Alarm Display

#### START TIME (0-255)

This setup determines the start-up time of the GP. Use this setup to adjust the power up sequence so that the GP starts up after the PLC.

#### TOUCH BUZZER SOUND

Setup whether or not the GP beeps when pressed.

#### BUZZER TERMINAL OUTPUT

Setup whether or not the *BUZZ* signal is output from GP's AUX I/F. This option is for an external buzzer.

#### PASSWORD (0-9999)

The password setup here is necessary to enter INITIALIZE, Off-line mode, etc. The password (*number*) ensures protection of the GP setups as Off-line mode cannot be entered inadvertently. Enter the optional number of your choice. If you do not wish to use this setup, enter the default **0**.

\*1 When using the Direct Access format or the Memory Link format, the object address becomes +9 or +12 respectively.

**DATA TYPE OF SCREEN NO.**

This setup controls whether BIN or BCD format numbers are used when making screen changes. Screen numbers 1 to 8999 are available when set up in binary format; screen numbers 1 to 1999 are available when set up in BCD format.

**2. SYSTEM AREA SETUP**

SYSTEM AREA SETUP is necessary for the PLC to administer the GP, and prepare the PLC internal Data Memory (DM) and Data Register (D). Use this setup to prepare the desired SYSTEM DATA AREA items.

**REFERENCE →** *PLC Connection Manual.*

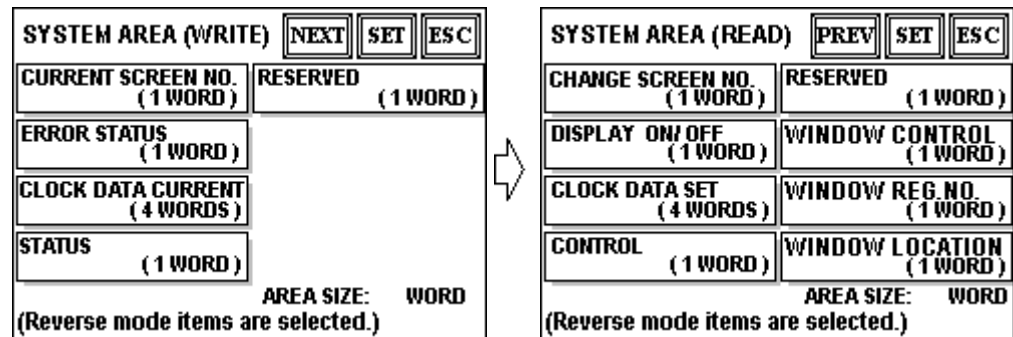

Press the **NEXT** and **PREV** buttons to toggle between the SYSTEM AREA WRITE and READ screens.

Press the item—when the item is highlighted, it is selected.

**System AREA SIZE**

This field displays the size, in words, of the items selected in the SYSTEM AREA (all the WRITE and READ items).

When you press the SET key, the SYSTEM AREA CONTENTS screen appears and ratifies the selected items



- The setup shown is efficient only when using the Direct Access format.
- The selected System Area items, as displayed on the screen, become the System Data Area.

When these five items, "Current Screen Number", "Error Status", "Clock Data (Current)", "Change Screen Number", and "Display On/Off", have been selected, word addresses are assigned to each item, in order, as shown on the next page.

# Initialize

 With the GP-PRO/PBIII for Windows95 “Simulation” feature, the GP’s “Setup Operation Surroundings” area cannot be used.

SYSTEM AREA CONTENTS		SET	ESC
WORD	WORD		
+0	CURRENT SCR.NO.	+10	
+1	ERROR STATUS	+11	
+2	CLOCK (CURRENT)	+12	
+3	CLOCK (CURRENT)	+13	
+4	CLOCK (CURRENT)	+14	
+5	CLOCK (CURRENT)	+15	
+6	CHANGE SCR.NO.	+16	
+7	DISPLAY ON/OFF	+17	
+8		+18	
+9		+19	



Addresses LS16 to LS19 are fixed as they control the Global Window. Other items cannot be set to these addresses.

The System Data Area selection process follows this formula [System Data Start Address + n]. For example, if the System Area Start Address was D00200, and the *Change Screen Number* option had been selected—if you refer to the System Area Contents screen displayed above, because *Change Screen Number's* address is pegged at +6, its word address would be D00200+6=D00206.

For more information on LS area 16 to 19  **PLC Connection Manual**, 1.1.2 "LS Area Structure"

### 3. GLOBAL WINDOW SETUP

The GP unit can display one *Global Window* and two *Local Windows* at any one time. The Global Window is common to all the display screens. The Local Window displays exclusively on the corresponding base screen. The GLOBAL WINDOW SETUP is described here.

GLOBAL WINDOW SETUP		PREV	SET	ESC
GLOBAL WINDOW ACCESS			DIRECT	
DATA FORMAT			BIN	
REGISTRATION NO. (1-256)			1	
LOCATION X (0-319)			160	
Y (0-239)			120	

#### GLOBAL WINDOW

When first entering the Global Window, select whether to **Use**, or **Do Not Use** the Global Window. If you select **Do Not Use**, ignore the items described below. Selecting **Use** makes these options available by simply pressing the NEXT button.

**GLOBAL WINDOW ACCESS**

Setup the Global REGISTRATION NO. and the Window LOCATION as *Direct* or *Indirect* values. When set as Direct, the REGISTRATION NO. and Window LOCATION selection are fixed to the values setup here. When set to Indirect, the WINDOW REG. NO. word address as prepared in the System Area is variable—which means it can have the REGISTRATION NO. *written* to it, and as a result, multiple window screens can be used as the Global window. Adjust the Global window position using this same method, by writing the X,Y coordinates to the SYSTEM AREA's WINDOW LOCATION word addresses.

**DATA FORMAT**

Setup whether the REGISTRATION NO. and the Window LOCATION values are inputted as BIN or BCD numbers. Only Direct values can be setup in these fields.

**REGISTRATION NO. (1-256)**

Setup the Window Screen Number used by the Global Window. This field is applicable only when the GLOBAL WINDOW ACCESS is set to Indirect.

**LOCATION**

Setup for the Global Window LOCATION. This field is applicable only when the GLOBAL WINDOW ACCESS is set to Indirect.

**4. CHARACTER STRING DATA SETUP**

*Character String Data* ordering varies from manufacturer to manufacturer. Setup the *Character String Data* order here to match the corresponding PLC.

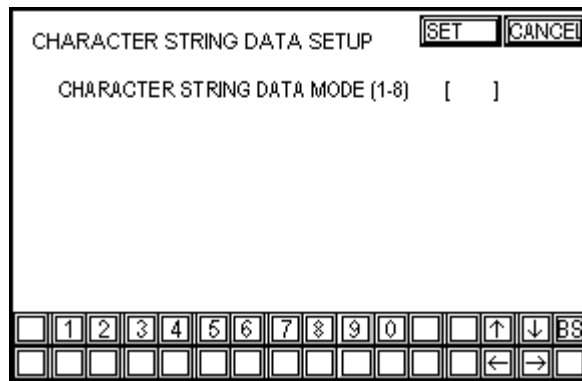

Setup the CHARACTER STRING DATA MODE to match the PLC type. Device type and Tag settings are unavailable.

Find the data storage order for your PLC in the table, next page, and setup the CHARACTER STRING DATA MODE.

- (I) Data Device Storage Order
- (II) Internal Word Byte LH/HL Storage Order
- (III) Internal Double-word Word LH/HL Storage Order



# Initialize

## CHARACTER STRING DATA MODE List

I) Data Device Storage Order	II) Internal Word, Byte LH/HL Storage Order	III) Double-word Internal Word LH/HL Storage Order	Character String Data Mode
Storage from Start data	LH order	LH order	<b>4</b>
		HL order	<b>2</b>
	HL order	LH order	<b>5</b>
		HL order	<b>1</b>
Storage from End Data	LH order	LH order	<b>6</b>
		HL order	<b>7</b>
	HL order	LH order	<b>8</b>
		HL order	<b>3</b>

### I) Data Device Storage Order

E.g. Characters A B C D E F G H  



#### • Storage from Start Data

①	D100
②	D101
③	D102
④	D103

#### • Storage from End Data

④	D100
③	D101
②	D102
①	D103

### II) Word Byte LH/HL Order

E.g. Characters A B C D  

#### • 16 bit Device LH Order

②	①	D100
④	③	D101

#### • 16 bit Device HL Order

①	②	D100
③	④	D101

#### • 32 bit Device LH Order

②	①	④	③	D100
---	---	---	---	------

#### • 32 bit Device HL Order

①	②	③	④	D100
---	---	---	---	------

**III) Double-word Word LH/HL Order**

E.g. Characters "A B C D E F G H I J"  
 ① ② ③ ④ ⑤

• 16 bit Device LH Order

②	D100
①	D101
④	D102
③	D103
⑤	D104

• 16 bit Device HL Order

①	D100
②	D101
③	D102
④	D103
⑤	D104

E.g. Characters "A B C D E F G H I J K L M N O P Q R S T"  
 ① ② ③ ④ ⑤ ⑥ ⑦ ⑧ ⑨ ⑩

• 32 bit Device LH Order

②	①	D100
④	③	D101
⑥	⑤	D102
⑧	⑦	D103
⑩	⑨	D104

• 32 bit Device HL Order

①	②	D100
③	④	D101
⑤	⑥	D102
⑦	⑧	D103
⑨	⑩	D104

**Relationship between K-tag Write Character Value and PLC Device**

• 16 bit Device

GP stores the character string from the start, as groups of 2, into 1 PLC Device.

When there are nine characters, they are arranged as shown below.

1 2 3 4 5 6 7 8 9 "  
 └─┘ └─┘ └─┘ └─┘ └─┘



When the characters do not divide into 2 evenly, NULL is added.

• 32 bit Device

GP stores the character string from the start, as groups of 4, into 1 PLC Device.

When there are nine characters, they are arranged as shown below.

1 2 3 4 5 6 7 8 9 "  
 └─┘ └─┘ └─┘



When the characters do not divide into 4 evenly, NULL is added.

## 5.4 SET UP I/O

This section describes the communication setup with the host PLC and the setup for any peripheral equipment. The SET UP I/O menu includes the SET UP SIO, SET UP I/O, and COMMUNICATION SETUP menus.

### 1. SET UP SIO

This menu runs the setups related to PLC communication. Match the settings listed below with the SIO setup on the PLC host side.

SET UP SIO	SET	ESC
COMMUNICATION RATE	9600	
DATA LENGTH	8 / 1	
PARITY	OFF	
CONTROL	ER-CNTRL	
COMMUNICATION INTERFACE	4 LINE	

#### COMMUNICATION RATE

The COMMUNICATION RATE (baud rate) is the data communication speed, measured in bits per second (bps), between the GP and PLC. Match the COMMUNICATION RATE values in both the PLC and GP.

#### DATA LENGTH

For data communications, the DATA LENGTH (the first numeral) must be set up as 7-bit or 8-bit data. The second value is the STOP BIT, which must be set up as either 1-bit or 2-bit.

#### PARITY

Set up whether no parity check, or an odd or even number parity check will take place during communication.

#### CONTROL

Data flow CONTROL prevents the overflow of data sent back and forth. Select either X-CNTRL or ER-CNTRL.

#### COMMUNICATION FORMAT

Select one of the following options for the communication format: RS-232C, RS-422 4 line, or RS-422 2 line.



When communicating with the Memory Link format using RS-422, select the 4-line option.

## 2. SET UP I/O

Touch operation and Force Reset setup, and Display Device adjustments are made here.

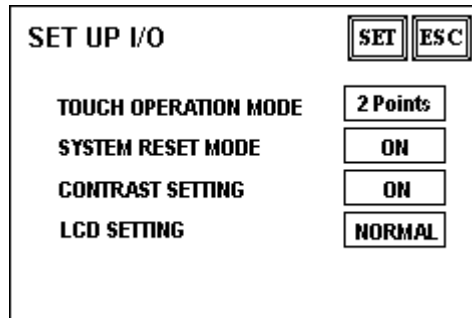

### TOUCH OPERATION MODE

Set up either One Point or Two Point input.

### FORCE RESET

Set up whether or not a FORCE RESET operation is in effect.

#### Steps to run FORCE RESET

While holding down the bottom right corner (1) of the screen, press the upper right corner (2). At the same time, press the bottom left corner (3) to enter the FORCE RESET Operation. To activate Reset, press the **RESET** button; to transfer to Off-line Mode, press **OFFLINE**.

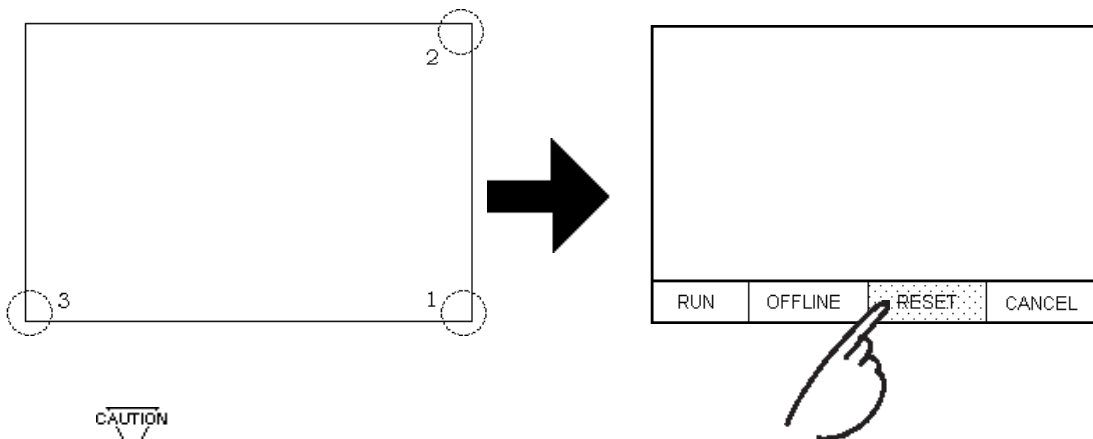

- FORCE RESET occurs even during RUN mode and Off-line mode.
- The FORCE RESET mode cannot be entered while waiting for the GP to start.
- Entering FORCE RESET is possible even when RUN operations (PLC <—>GP communication) do not occur.

# Initialize

## CONTRAST ADJUSTMENT

When this option is set On, CONTRAST ADJUSTMENTS can be made through touch input.

While pressing the upper right hand corner (1) of the screen, press the upper left corner (2) to enter CONTRAST ADJUSTMENT mode. Press the desired setting and the screen's contrast will change accordingly.

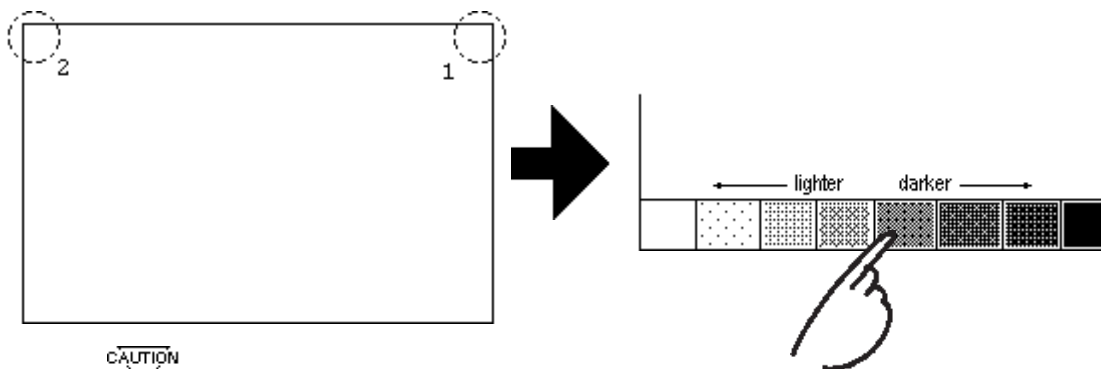

• For the GP270-LG\*\* models, the lighter and darker settings are on the opposite side.



- To exit CONTRAST ADJUSTMENT mode, press anywhere outside the contrast option bar.
- CONTRAST ADJUSTMENT mode cannot be entered while waiting for GP to start.
- CONTRAST ADJUSTMENTS can be made even in the middle of RUN mode (PLC $\longleftrightarrow$ GP communication).

## LCD SETTING (Only for GP-270LG\*\*)

There are two options: REVERSE and NORMAL. When set to REVERSE, the screen lighting becomes inverted.

Press the LCD SETTING item to change it from NORMAL to REVERSE, then press the SET button. The screen display reverses and returns to the previous screen.

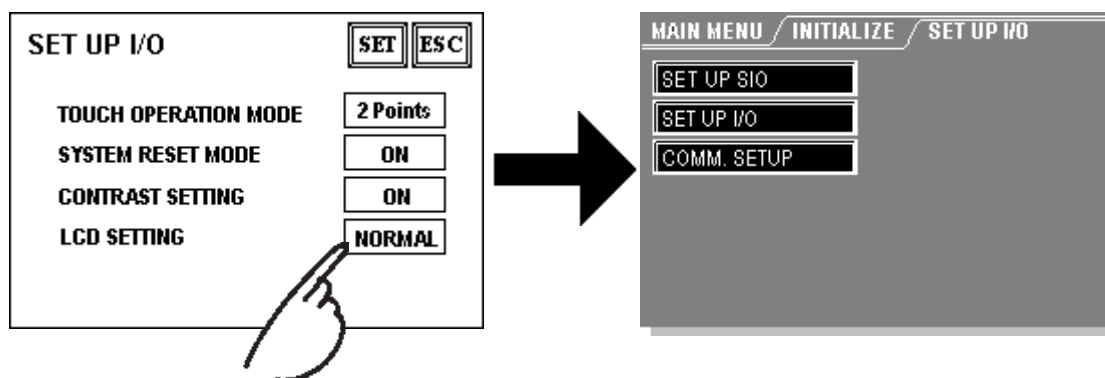

### 3. COMMUNICATION SETUP

---

These fields set *when* an error message is reported, after a GP $\longleftrightarrow$ PLC communication error is detected. This ensures an error has actually taken place and not just slight breaks in communication or slowness in processing data on one side or the other.

COMMUNICATION SETUP		SET	ESC
RECEIVE TIMEOUT ( 1~127 )	10	sec	
RETRY COUNT ( 0~255 )	2		

#### RECEIVE TIMEOUT

Set up how long the GP unit will wait when there is nothing being sent to it. (This is the *Timeout Time*.) However, if there is no cable connected up, then regardless of the time set up here, the Timeout value would be 1 second. The default value is 10 seconds.



When a value of over 30 seconds is set here, and a screen is transferred from the PC while a PLC Communication Time error has occurred, an error may also appear on the PC side.

#### RETRY COUNT

Set up the number of times the GP will try to send data when a Communication error occurs. The default value is 2 times.

## 5.5 PLC SETUP

Setup the System Area and the Unit number on this screen. Because 1:1 and n:1 GP connections change the setup contents, check it before running any setups.

### 1. SET UP OPERATION SURROUNDINGS (1:1)

Setup the PLC System Data Area and the Unit Number here.



This setup is only necessary when using the Direct Access format.

SET UP OPERATION SURROUNDINGS		SET	ESC
SYSTEM AREA START DEV		D	
START ADR		0	
UNIT NO.		0	
SYSTEM AREA READ SIZE		0	

#### SYSTEM AREA STARTING ADDRESS

Setup the PLC's Data Register (D), Data Memory (DM), etc. allotted by the SYSTEM AREA STARTING ADDRESS. (The START DEV display changes with different PLC's.)

#### UNIT NO.

Set up the PLC UNIT number here. Make sure it matches the one set up in the PLC.

#### SYSTEM AREA READ SIZE

When using a Block Display Trend Graph, setup the Reading Area Size (in word units) to match the Trend Graph's data size. Set this up when you wish to allocate the Reading Area in the PLC Data Register (D), or Data Memory (DM).



- If you are not using the Reading Area, leave the **0** default values intact. High Speed Communications can be secured as a result.
- When using Hitachi's HIDIC-S10  $\alpha$  Series, an extra item titled "Extended Memory Address (HIDIC) [000000]" is added to the above screen display. Values accepted by the extended memory start address are **0** (memory not extended), and **100000 to 1FF000**.



- When using Matsushita Electric's NEWNET-FP, an extra item titled "Monitor Register" is added to the screen display. If using 2 or more CCU's (communication unit) as in the following diagram, and a GP is connected to each CCU, select the 1:1 connection and setup the Monitor Register as "None".

## 2. SET UP OPERATION SURROUNDINGS (n:1)

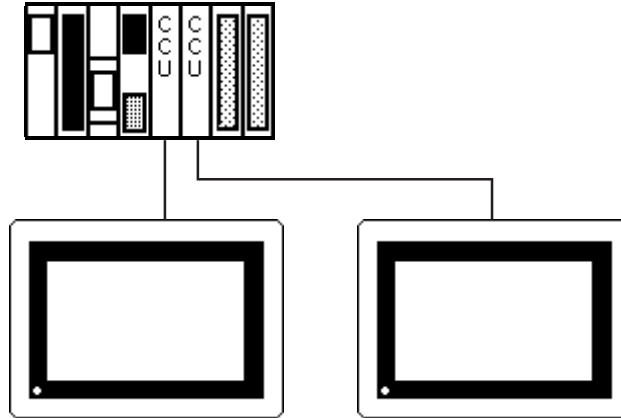

This is the setup for the PLC System Data Area and the Unit Number for an n:1 (multi-link) PLC connection. For more about the SYSTEM DATA AREA with the n:1 (multi-link) connection, [REFERENCE → GP-PRO/PB 3 PLC Connection Manual](#).



This setup is only necessary when using the Direct Access format.

SET UP OPERATION SURROUNDINGS		SET	ESC
SYSTEM AREA START DEV		D	
START ADR		0	
UNIT NO.		0	
SYSTEM AREA READ SIZE		0	

### SYSTEM AREA STARTING ADDRESS

Setup the PLC's Data Register (D), Data Memory (DM), etc. allotted by the SYSTEM AREA STARTING ADDRESS.

### UNIT NO.

Set up the PLC UNIT number here. Make sure it matches the one set up in the PLC.

### SYSTEM AREA READ SIZE

When using a Block Display Trend Graph, setup the Reading Area Size (in



# Initialize

word units) to match the Trend Graph's data size. Set this up when you wish to allocate the Reading Area in the PLC Data Register (D), or Data Memory (DM).



- If you are *not* using the Reading Area, leave the **0** default values intact. This will allow you to perform high speed communication.

### 3. STATION SETUP (n:1)

The STATION SETUP, necessary for the n:1 (multi-link) setup, checks whether correct communications run with the connected GP System configuration.

#### NETWORK INFORMATION ADDRESS

In the n:1 (multi-link) connection, the Network Information uses 2 words in its correspondences. These 2 words are the *Connection* part and the *Validation* part (described later in this section). Allocate these respective areas into the PLC's Data Register (D) or Data Memory (DM).

#### PLC Data Register

+0	CONNECTION PART	PLC-->GP
+1	VALIDATION PART	GP-->PLC



In the NETWORK INFORMATION ADDRESS, setup all the GP's connected to the same link unit with the same address. Furthermore, when there are 2 ports in the connected link unit, do not make these use the same address.

#### • Connection Part

The word address for the Connection Part sets up the number of GP's connected to the PLC, registered beforehand on the PLC side. When these GP's are connected to the PLC, the corresponding PLC bit numbers for the particular GP Stations (see bottom) turn on.



When the GP is connected to the PLC, and the option of GP only correspondence ends and Offline mode is entered, the GP Station Number turns the corresponding PLC bit off.



For example, when these 4 GP units—bit 0, bit 2, bit 3, bit 5—are connected, 002D (h) is written here.

Connection Part 

0	0	0	0	0	0	0	0	0	0	0	0	1	0	1	1	0	1
---	---	---	---	---	---	---	---	---	---	---	---	---	---	---	---	---	---

 002D (h)



- Be certain to setup before running.
- Turn bits *not* connected to the GP off.

## • Verification Part

This area responds to the correspondence from each connected GP. When the same bit numbers as the Connection Part turn On, the correspondence is accepted by the Verification Part. In turn, the Station Numbers of the communicating GPs turn their corresponding PLC bit number on.

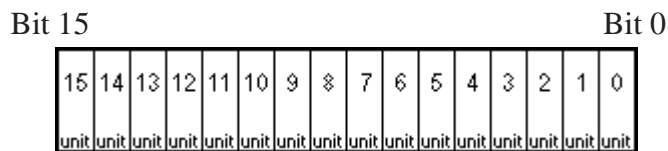

If the correspondence between the GP and PLC is correct, the same value as in the Connection Part writes to the Verification Part.

For example, the value 002D (h) in the Connection Part, setup as the 0 bit, 2 bit, 3 bit, and 5 bit, writes to the Verification Part as shown below.

Connection Part 

0	0	0	0	0	0	0	0	0	0	0	0	0	1	0	1	1	0	1
---	---	---	---	---	---	---	---	---	---	---	---	---	---	---	---	---	---	---

 002D (h)

Verification Part 

0	0	0	0	0	0	0	0	0	0	0	0	0	1	0	1	1	0	1
---	---	---	---	---	---	---	---	---	---	---	---	---	---	---	---	---	---	---

 002D (h)



- When the Connection Part and Verification Part do not match, a COMMUNICATION ERROR occurs. Check the setup again.
- When changing the connection, first turn all the bits Off.

## STATION NO.

This is the setup for the number of GP Stations in use, as mentioned in the above section. The setup range is from 0 to 15, and the only other restriction is each GP STATION NO. must be unique in the system. If STATION NO.'s are repeated, a COMMUNICATION ERROR occurs.



- The STATION NO. is the number allocated to the particular GP unit. This number is not related to the Link Unit Machine number.

## 4. CUSTOMIZE SETUP

---

The Customize function alters the n:1 (multi-link) connection's communication to make it more effective. To run communication efficiently, determine whether to use Operation or Display priority with your GP. As a result, the communication response speed can be upgraded, although the speed changes with the screen information.

CUSTOMIZE SETUP		SET	ESC
PLC PRIORITY		OPE.	
GP TOUCH MONOPOLIZE		OFF	
MONOPOLIZE TIME	0		*10 sec

### PLC PRIORITY

According to how the GP is used, select either Operation priority (OPE.) or Display priority.

- Display

Setup the GP to this option when using the GP mainly as a monitor screen. The GP will command a higher display speed as a result; however, the response time for the touch panel's operations will slow.

- Operation

Setup the GP to this option when using the GP mainly as an operation panel. As a result, the GP will command better touch panel numeric input and switch response times.

Leaving the GP in this mode does not influence the touch panel operation response time of the rest of the GP's very much; however, the screen display renewal cycle will slow down



- In a basic setup, run the same setup for all connected GP's.
- To increase the display speed, restrict addresses used to consecutive addresses wherever possible. And make bit addresses consecutive to the word unit.

- Display Priority and Operation Priority Speed Difference

When using the Mitsubishi Electric Corp. A3A PLC, with a scan time of 20ms with consecutive addresses (80 words not included in the System Area), the difference in speed when reading is as shown in the following graphs.

Display Priority and Operation Priority Speed Difference

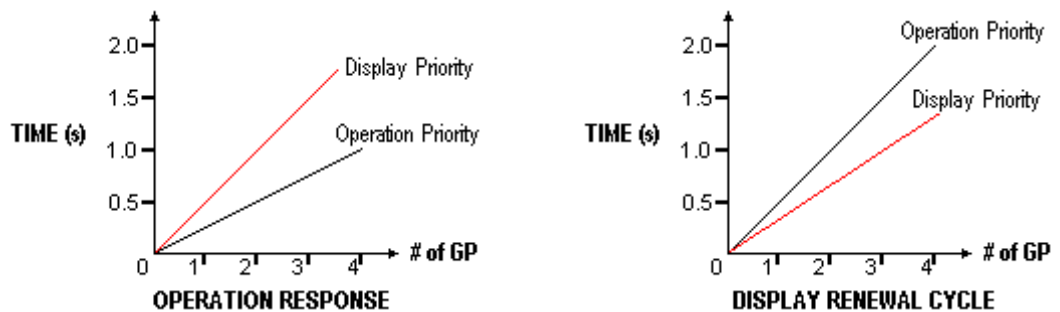

### GP TOUCH MONOPOLIZE

The monopolizing of touch panel use can be set On or Off. When you want to use the PLC exclusively with a Momentary operation setup on the touch panel (REFERENCE → *GP-PRO/PB 3 PLC Connection Manual*), turn GP TOUCH MONOPOLIZE on.

When this setup is on, the touch panel uses the PLC exclusively whenever the momentary operation setup on the panel is pressed. In this way, you can use the inching operation with a momentary switch. When you stop pressing the panel, exclusive use ends.

### MONOPOLIZE TIME (0-2550s)

This field controls the length of time for the monopolize procedure when no other touch panel operations are performed. The Monopolize process begins when the System Data Area's 7th bit of word address LS14 turns on, and ends either when the bit turns off, or when the time set here passes.



- Pressing the touch panel in the middle of the monopolize process interrupts the MONOPOLIZE TIME function, ending exclusive use.
- When MONOPOLIZE TIME is set to **0**, the monopolize function does not end automatically.

For more about the contents of System Data Area LS6 (status) and LS14 (control) (REFERENCE → *GP-PRO/PB 3 PLC Connection Manual*).

## 5.6 INITIALIZE MEMORY

This command erases all the GP screen data.



- You cannot cancel the Initialization procedure after pressing the Start key.
- Initialization does not erase the SYSTEM SET UP, the SIO protocol, nor the internal clock setups.

INITIALIZE INTERNAL MEMORY 

WARNING: PREVIOUS DATA WILL BE  
OVERWRITTEN!

ENTER PASSWORD AND PRESS  
START KEY ?





To initialize the GP internal memory, enter the common password **1101**, or the password entered in the SYSTEM SET UP screen.



Initialization takes 10 to 20 seconds.

## 5.7 SET UP TIME

SET UP TIME  

PRESENT TIME  
'95 Y 1 M 15 D 22:16

TIME SET UP  
'  Y  M  D  :

Set up the internal timepiece of the GP. Make date and time corrections in the TIME SET UP fields.



The time—displayed on the screen using the Time Display function—is not completely accurate. At room temperature, the GP internal clock has an accuracy of +/- 40 seconds/month. The surrounding temperature and age of the unit can decrease the accuracy to +65 ~ -350 seconds/month. However, the screen Time displays only up to the minute.

**5.8 SET UP SCREEN**

The initial screen display upon powering up, the alarm character size, and other related items are setup here.

SET UP SCREEN		SET	ESC
INITIAL SCREEN NO.	B	1	
ALARM MESSAGE V SIZE		1	
H SIZE		1	
ONLINE ERROR DISPLAY		ON	

**INITIAL SCREEN NO.**

Set up the screen file number that will display first upon powering up. If the BIN option for DATA TYPE OF SCREEN NO in SYSTEM SET UP had been selected, enter a number from 1 to 8999. Or, if BCD was the option set up, then input a number from 1 to 1999.

**ALARM MESSAGE**

Set up the character size of the ALARM MESSAGE when the Alarm Bulletin is activated.

<When using syngle-byte characters>

1	2	4
V size=1; H size=1 16×8 pixels	V size=2; H size=2 32×16 pixels	V size=4; H size=4 64×32 pixels

<When using double-byte characters>

V size=1; H size=1 16×16 pixels	V size=2; H size=2 32×32 pixels	V size=4; H size=4 64×64 pixels
------------------------------------	------------------------------------	------------------------------------

**ONLINE ERROR DISPLAY**

Set up whether or not error messages display during RUN mode.

## 5.9 FONT SETTING

FONT SETTING		SET	ESC
FONT SETTING		I-ASCII	
KANJI FONT QUALITY		HIGH	

### FONT SETTING

Select the character font that displays during RUN mode. Available selections are [EUROPE], [JAPAN], [KOREA], [CHINESE] and [TAIWAN-ESE].

### KANJI FONT QUALITY

◆ When [FONT SETTING] is set to [JAPAN]

Full sized characters:

[STANDARD] : Full sized 16-dot characters display. When enlarged, this font will remain a 16-dot character. (Compatible with GP-\*30 series units.)

[HIGH]: Any character which is Level 1 JIS Kanji Code standard larger than 2 x 2 will display as a 32-dot character. Level 2 JIS Kanji Code standard characters, no matter what the current font setting is, will always display using 16 dots. (Compatible with GP-\*50 and GP-\*70 series units.)

[1,2]: Level 1 or 2 JIS Kanji Code standard characters that are larger than 2 x 2, will display as 32-dot characters.

◆ When [FONT SETTING] is set to any other type

A full sized character (except Alphabets) is displayed with 16-dot font, even when it is displayed with an enlarged size. Half sized characters are displayed as:

[STANDARD]: 16x8-dot characters display. When enlarged, this font will stay as 16x8-dot character. (Compatible with GP-\*30 series units.)

[HIGH]: Alphabets and numerals (exceptions not included) will display as high quality font-character.

[1,2]: Alphabets and numerals (exceptions not included) will display as high quality font-character.

The [HIGH] selection is factory set.





## Chapter 6

# RUN and Errors

1. RUN
2. Troubleshooting
3. SELF-DIAGNOSIS

This chapter describes the GP RUN and problem solving processes.

### 6.1 RUN

There are two ways of entering RUN mode, from powering up and from Off-line mode.

#### 1. Powering Up

Activate the GP unit. After the unit has powered up, the START TIME value—set up in INITIALIZE/ SYSTEM SET UP—determines how long the display, illustrated below, appears, until it gives way to the screen number setup in the INITIALIZE/ SET UP SCREEN menu. However, if a screen has not been set up, or if the screen set up does not exist, then the display below will remain.

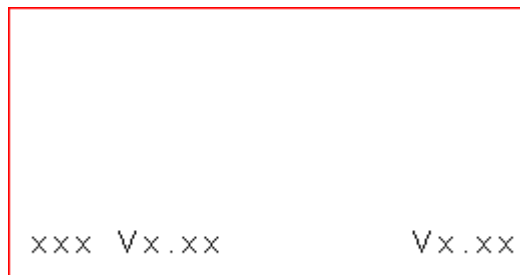

#### 2. Off-line Mode

Press Off-line mode's MAIN MENU item number 4, RUN. The INITIALIZE/ SET UP SCREEN option determines the first screen that appears in RUN mode, thereby beginning communication with the PLC. However, if a screen has not been set up, or if the screen set up does not exist, then the display above remains.

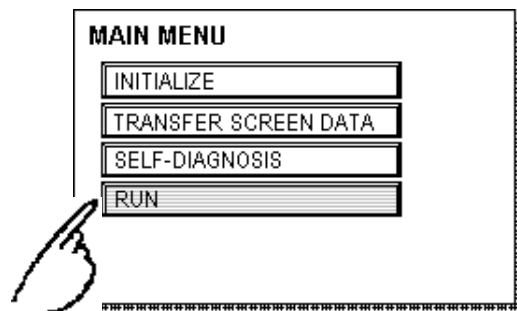

Press the top left corner within 10 seconds of starting RUN to enter Off-line Mode.



E.g. After powering up, the initial Screen is equipped with a Switch in the top left corner. If this Switch is pressed within 10 seconds, it changes the GP status from RUN mode to Off-line mode.

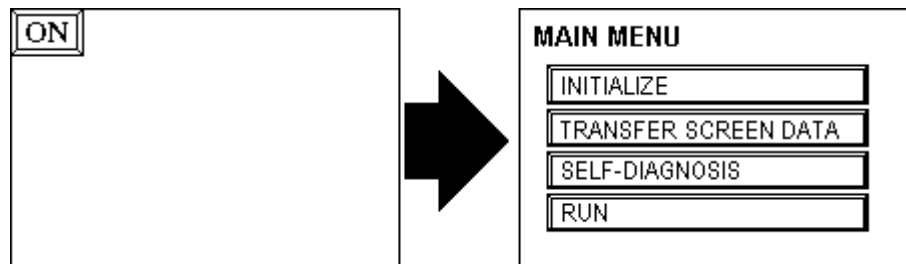

## 6.2 Troubleshooting

This section describes how to find and resolve problems that may occur on the GP. If there is a problem on the PLC side, refer to the corresponding PLC manual.

### 1. Trouble Types

Shown below are some problems that may occur while using this unit.

(1) No Display

The screen will not display even when the unit is powered On. Also, during RUN mode, the screen disappears.

(2) No Communication

The GP unit cannot extract data from the host. An error message may appear on the screen as a result. For more about error messages, refer to the section in this chapter titled, "Error Messages".

(3) Touch Panels Do Not Function

The touch panel does not react when pressed, or the reaction time is very slow.

(4) Off-line displays During RUN Mode.

## Run & Errors

For the first three problems, see the *flowcharts* listed on the following pages. For the last problem, a SYSTEM ERROR may have developed while displaying the Off-line mode screen. Refer to Chapter 6.4, "Error Messages—Details". However, this is not a problem when having entered Off-line mode by pressing the top left corner within ten seconds of powering up.



- Because of the danger of electric shocks, make sure the power is *not* supplied before wiring the unit.
- When changing the backlight, there is the danger of electric shocks and burns, so be sure to use gloves when working on the unit.



This section assumes that the cause of any problems comes from the GP, and not from the host. When the host PLC is the problem, refer to the corresponding PLC manual.

## 2. No Display

Follow the flowchart below when the screen does not display when powering up, or the screen turns Off by itself during RUN mode, to find an appropriate solution.

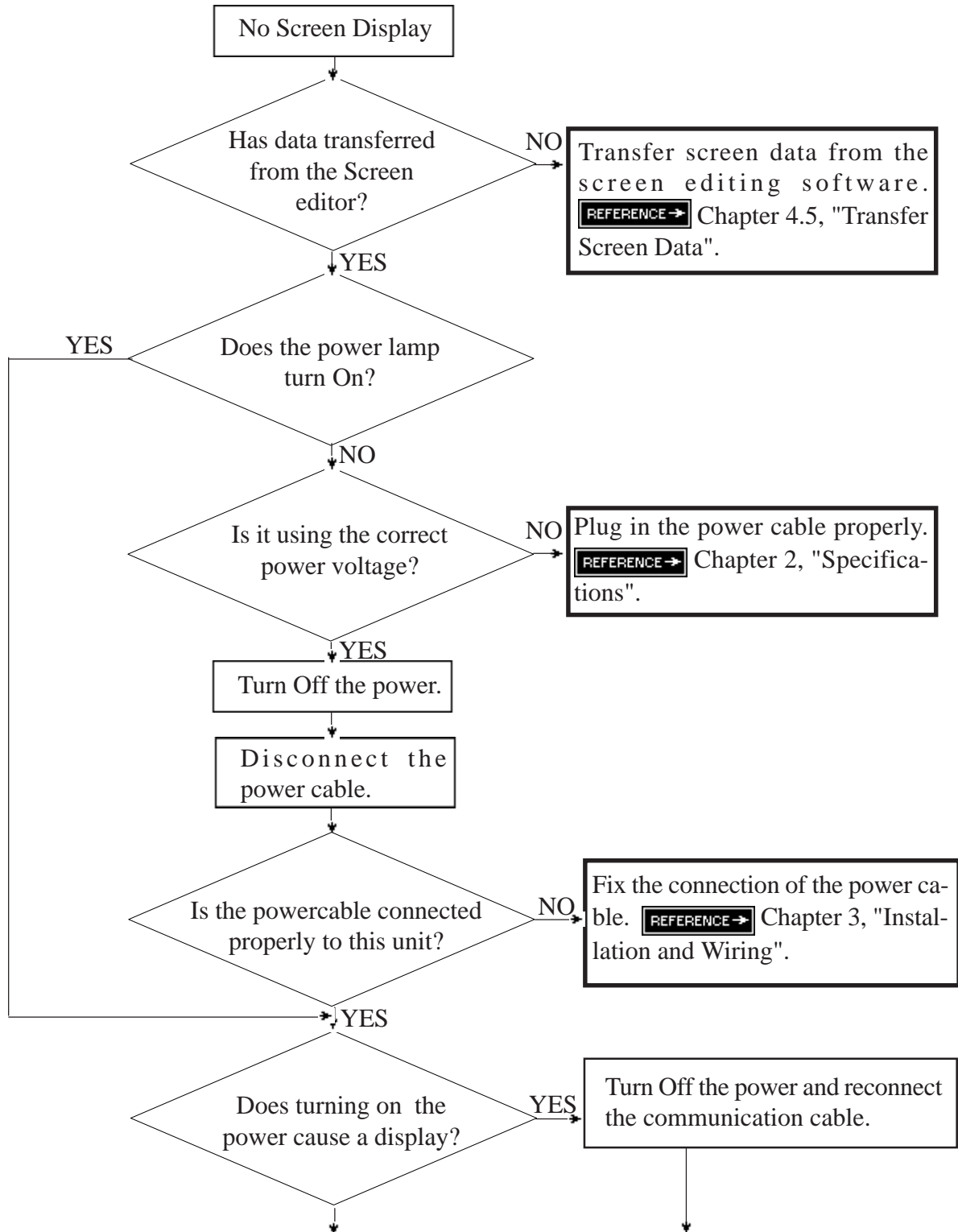

## Run & Errors

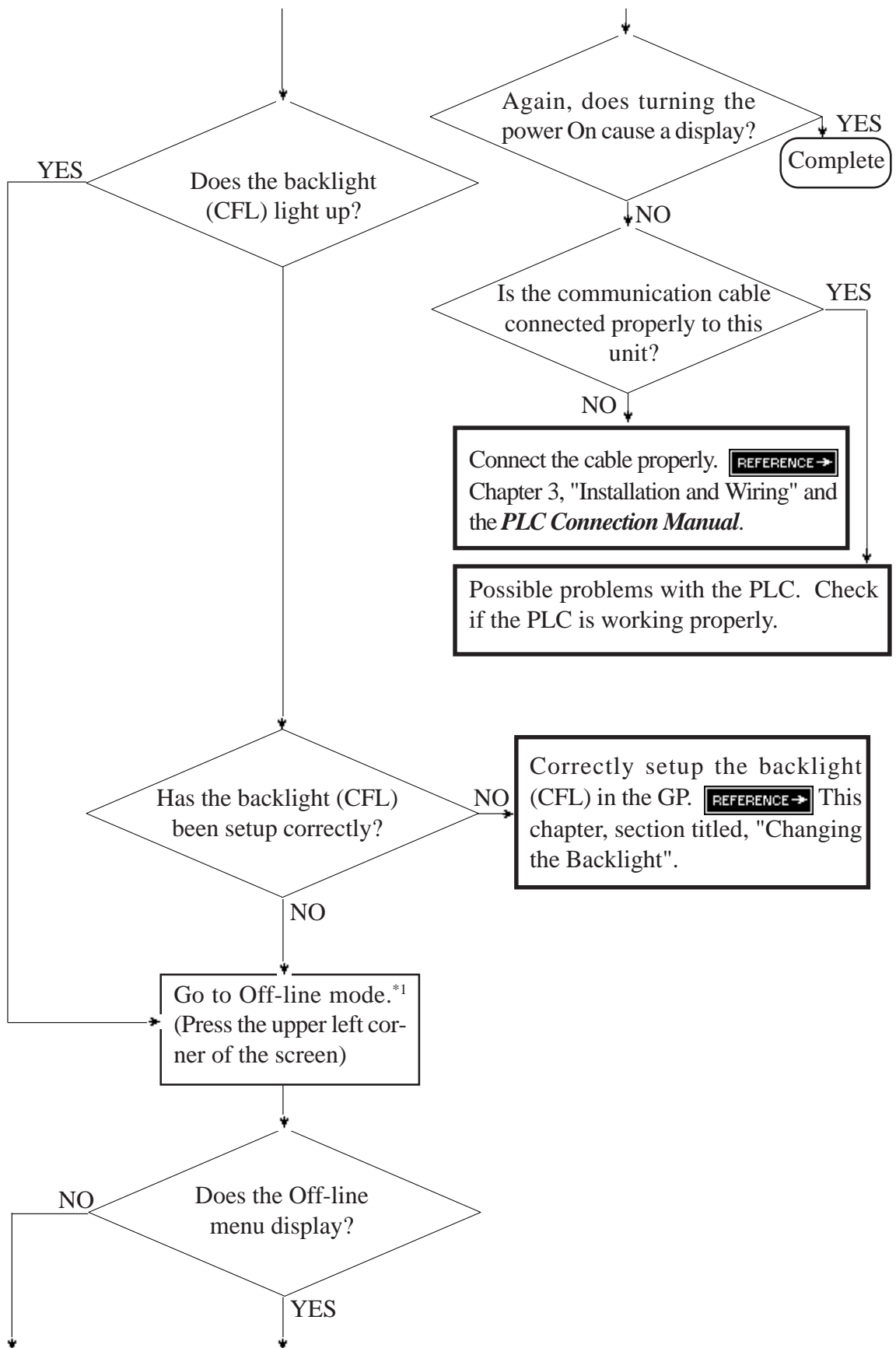

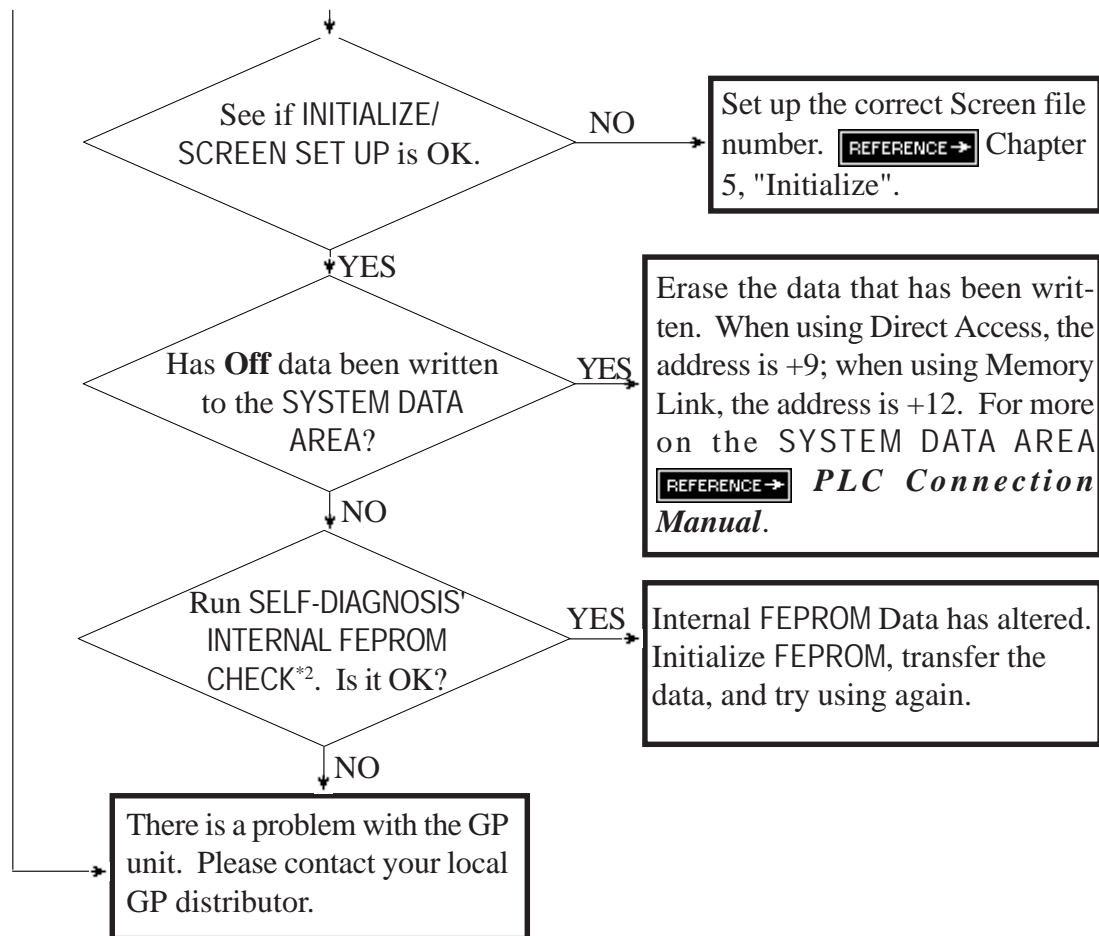

\*1 To make the Off-line screen appear, turn the power Off, then back On, and press the upper left corner of the screen within 10 seconds.

\*2 When you run the FEPROM CHECK in SELF-DIAGNOSIS, *all* the screen data gets erased. Be sure to make a backup of all the screens.

## 3. Would Not Communicate

When the GP will not communicate with the host PLC, follow the flowchart below to discover the origin of the problem and find a suitable response.

Or, if an error message displays on the screen, check the error code—[REFERENCE →](#) *Error Message* section in this chapter—to find the appropriate solution.

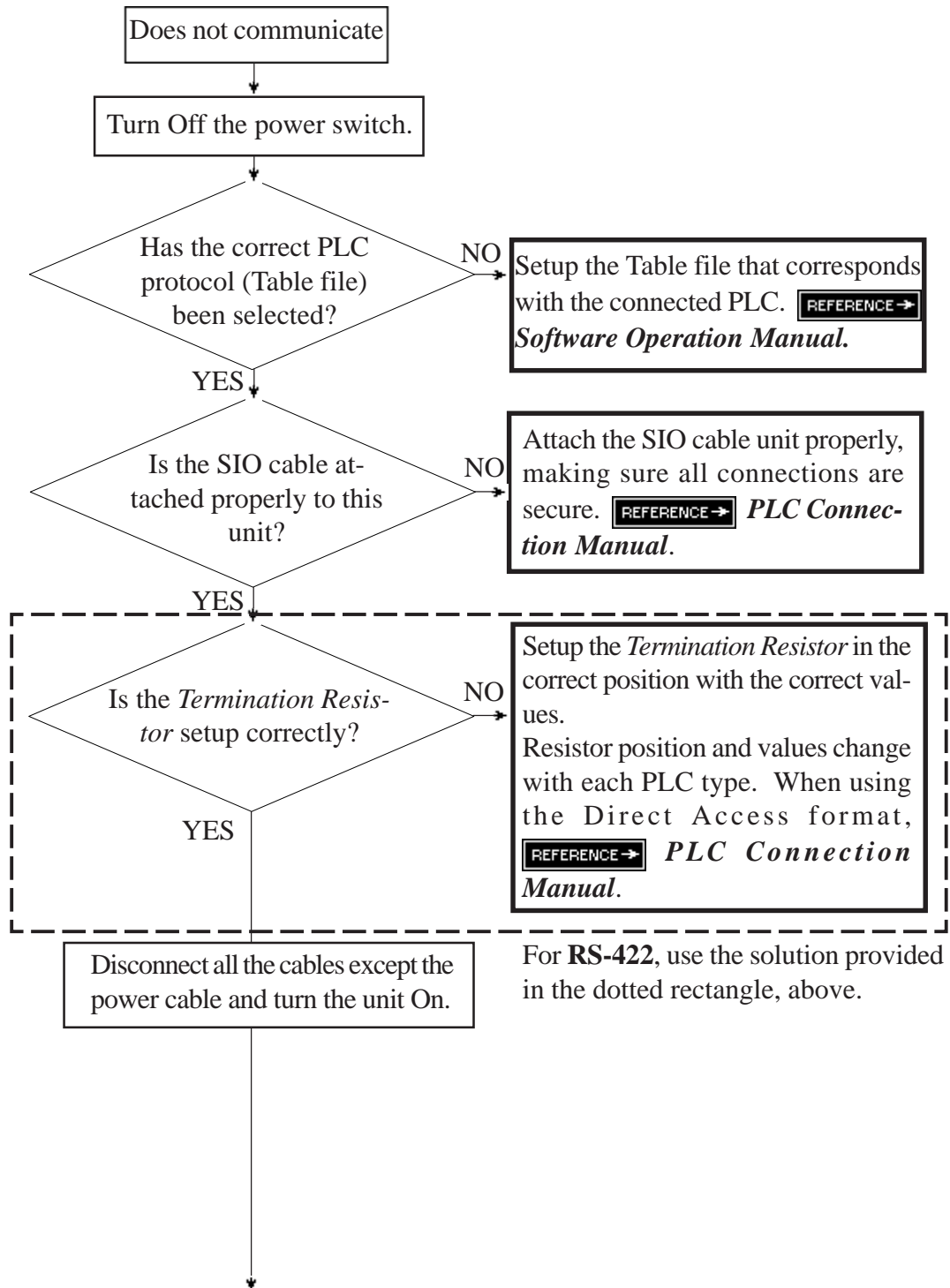

For **RS-422**, use the solution provided in the dotted rectangle, above.

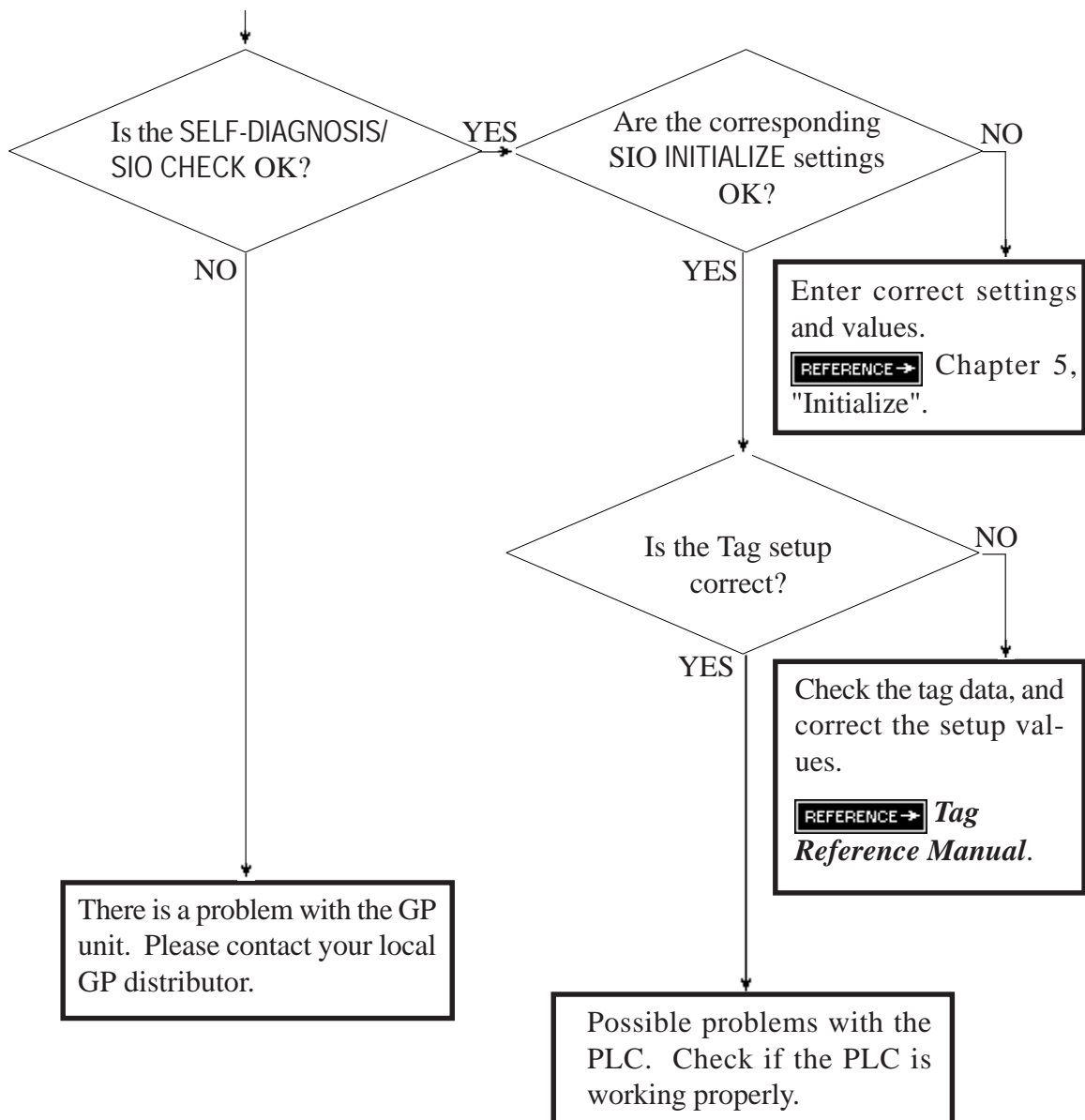

- To run SELF-DIAGNOSIS's SIO CHECK options, special tools become necessary.



For details about SELF-DIAGNOSIS, refer to the SELF-DIAGNOSIS section in this chapter.



## 4. The Touch Panel Does Not Respond

When the touch panel does not react, or its reaction time is very slow after it is pressed, please follow the flowchart below to find the origin of the problem, and the appropriate solution.

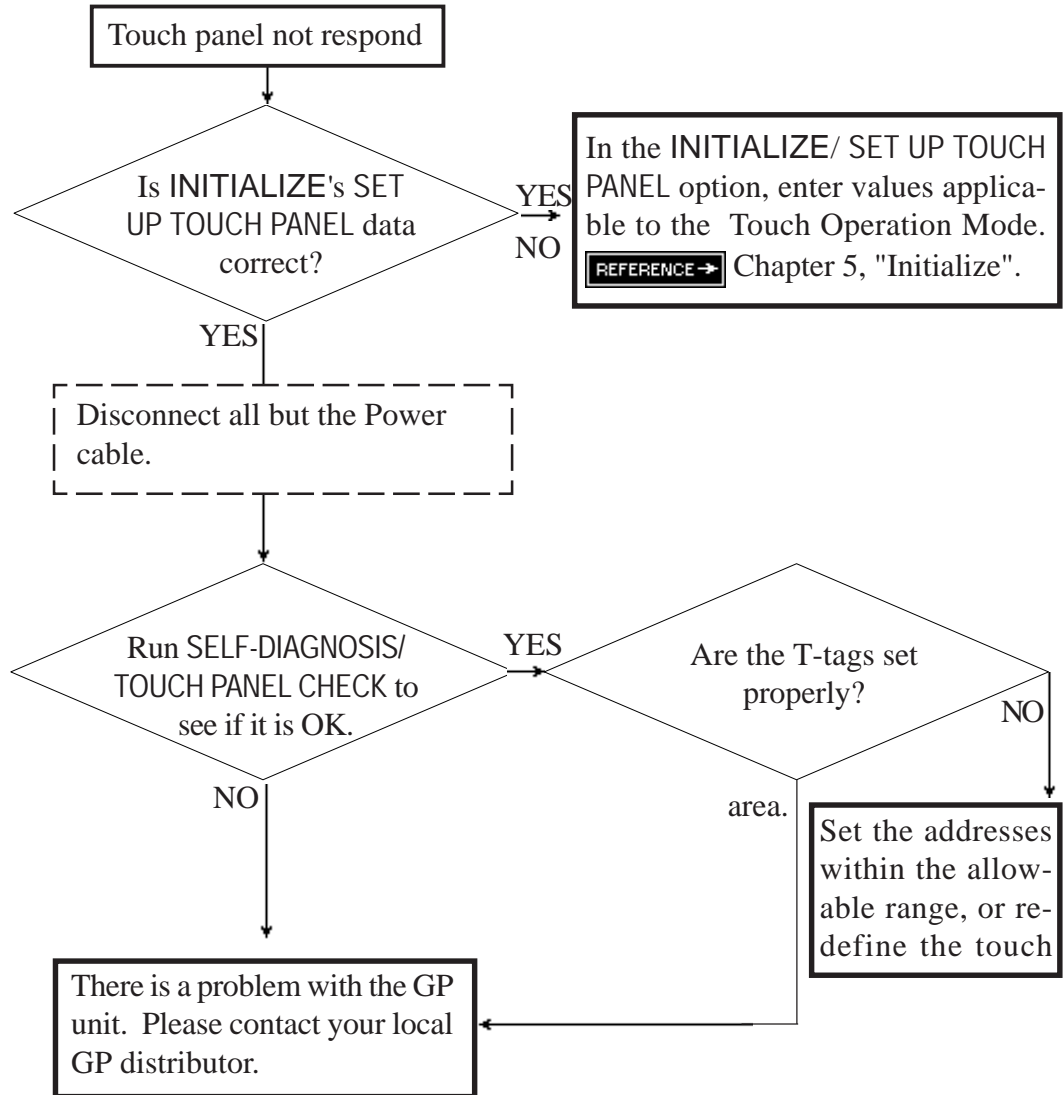

## 6.3 SELF-DIAGNOSIS

The GP unit is equipped to check its own System and Interface for any problems. Use it to help diagnose any problems.

### 1. SELF-DIAGNOSIS Item List

MAIN SELF-DIAGNOSIS MENU	
DISPLAY PATTERN	INPUT PORT
TOUCH PANEL	SIO CHECK
FEPROM CHECKSUM	
FRAME BUFFER	
TOOL CONNECTOR	

- **DISPLAY PATTERN**  
Displays all the figures and tiling patterns to check if they are correct.
- **TOUCH PANEL**  
Checks the touch panel squares.
- **FEPROM CHECKSUM**  
Runs the GP internal memory's (FEPROM) system and protocol checksum.
- **FRAME BUFFER**  
Checks the GP internal display memory (FRAME BUFFER).
- **\*TOOL CONNECTOR**  
Checks the control lines and input/output lines for the tool connector.
- **INPUT PORT** (for Digital's maintenance use only)  
Runs a check on the Input Port.
- **\*SIO CHECK**  
Checks the input/output lines for the RS-232C and RS-422 terminals.



The SELF-DIAGNOSIS items marked with an asterisk (\*) require special tools. Please prepare the required tool for each test.

## 2. SELF-DIAGNOSIS—Details Of Each Item

This section explains the contents of SELF-DIAGNOSIS. For information about how to operate the Screen, [REFERENCE →](#) Chapter 4, "Off-line Mode"; for information about how to set up the *Special Tools*, [REFERENCE →](#) Chapter 3, "Installation and Wiring".

### DISPLAY PATTERN

Checks the drawing function and Kanji ROM for when the device contents will not display correctly, by running checks on the various screen pattern displays. If everything is normal, **OK** displays; if there is a problem, **NG** displays.

### TOUCH PANEL

Touch Panel check. Checks if each touch cell highlights when pressed.

### INTERNAL FEPRM CHECKSUM (System & Protocol)

The Internal FEPRM System and Protocol check searches for any problems that may arise during operations.

When the FEPRM is normal, **OK** displays; if there is a problem, an error message appears. This check does not erase the System or Protocol.

### FRAME BUFFER

The Frame Buffer (display memory) Check looks for any display problems that may develop. When everything is normal, **OK** displays; when there is a problem, an error message displays.

### TOOL CONNECTOR LOOP BACK

Use the Tool Connector Control line and Send/Receive line check when the GP cannot send and receive data from the PC. To run the check, connecting a *Tool Connector Check Loop Back Cable* (Dsub25 pin female connection) mounted to the *Downloading Cable* (provided in your software package) is necessary. *See diagram next page.*

When everything is normal, **OK** displays; when there is a problem, an error message displays.

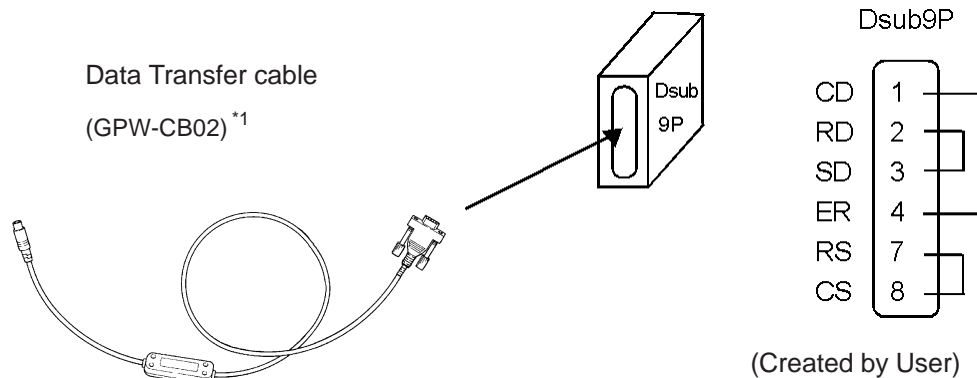

## INPUT PORT

Used by Digital for maintenance purpose.

## SIO CHECK

Checks the RS-232C and RS-422 I/O lines for areas where correspondence problems develop. In the menu, select which check to run. To run the check, a serial interface cable connection becomes necessary. If all is normal, **OK** displays; if there is a problem, an error message appears.

The Serial Interface cable wiring for each check is as shown below.

### • DTR CHECK

Connect the DTR Loop Back cable to the GP's serial interface. If all is normal, **OK** displays; if there is a problem, an error message appears.

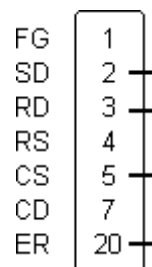

### • RTS CHECK

Connect the RTS Loop Back cable to the GP's serial interface. If all is normal, **OK** displays; if there is a problem, an error message appears.

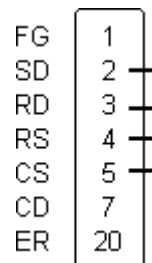

### • RS-422 CHECK

Connect the RS-422 Loop Back cable to the GP's serial interface. If all is normal, **OK** displays; if there is a problem, an error message appears.

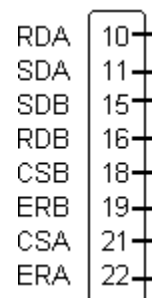

### 6.4 Error Message

This section explains the messages that appear when an error has occurred in the GP unit during RUN mode. The origin of the problem behind each error message is explained with appropriate ways of disposing of the error.

After a problem has been solved, turn the power Off, then On, and restart the GP.

#### 1. Error Message List

---

The error messages listed below appear on the GP unit. Instructions on how to find and solve error messages are explained on the following pages.

- SYSTEM ERROR
- ILLEGAL ADDRESS IN SCREEN DATA
- UNSUPPORTED TAG IN SCREEN DATA
- PLC NOT CONNECTED (02:FF) and (02:F7)
- PLC NOT RESPONDING (02:FE)
- RECEIVE DATA ERROR (02:FD)
- PLC COM. ERROR
- SCREEN MEMORY DATA IS CORRUPT
- CLOCK SETUP ERROR
- SCREEN TRANSFER ERROR
- OBJ. PLC HAS NOT BEEN SETUP
  
- GP STATION NO. DUPLICATION ERROR (02:F9)
- NETWORK ADDRESS ERROR (02:F8)



If there is more than one error, the GP displays the error message for the last error detected.

**2. Error Messages—Details**

---

**SYSTEM ERROR**

Indicates a fault in the basic operations of the GP.

Following the error message, an error code, as shown, will appear. Report the error number, and details on how the error developed, to your local GP distributor.

- **SYSTEM ERROR ( 03 : x x )**  
 Displays when a PC transferred file cannot be rebuilt.

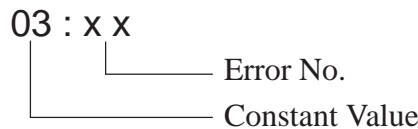

- **SYSTEM ERROR ( x x x : x x x : x x x )**  
 Displays in RUN mode when a file cannot be rebuilt.

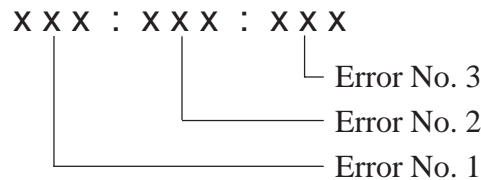

- **Offline mode displays while in RUN mode**  
 When the GP changes to Off-line mode without pressing the screen, there is a possibility that the screen data has been damaged. When the screen data is damaged, after the SYSTEM ERROR displays, the screen automatically reverts to Off-line mode after about 10 seconds. Run the INITIALIZE MEMORY command and transfer the GP screen data again from your PC.

**ILLEGAL ADDRESS IN SCREEN DATA**

This error message is caused by an overlap of addresses.

Following the error message, error codes, as listed below, appear. If the error cannot be fixed, please report the error code and details on how the error developed to your local GP distributor.

**ILLEGAL ADDRESS IN SCREEN DATA ( 0 0 B : x x x : x x x )**

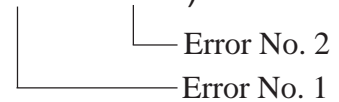

*See the Table next page*

## Run & Errors

### Overlapping Addresses

Error 1	Error 2	Contents
0C1	191	All or part of the T-File* <sup>1</sup> or S-tag address range overlap the addresses of System Data Area.
	192	
	193	
0C2	194	All or part of the System Data Area address, A-File* <sup>1</sup> or S-tag address range overlap the addresses setup in a T-File.
	195	
	196	
0C3	197	All or part of the T-File* <sup>1</sup> , or the S-tag or K-tag address range overlap the address range set in an A-file.
	198	
	199	

Overlapping addresses, other than the ones mentioned above, can also cause the Illegal Address message.



E.g. When the starting address of the System Data Area is set to 100, and the tag below is setup:

Tag Name/ Part ID No.	Word Address	Tag Format
N1	99	BCD32

The N-tag is set to 32 bits, meaning it uses two word addresses. Since the first address is 99, the second address must be 100. Address 100 is ineligible for use since it has already been used for the System Data Area.

### UNSUPPORTED TAG IN SCREEN DATA

A list of tag(s) in use that are unsupported by the current GP version appear with this error message. Setup the tags to correspond with the GP.

For details about tags, [REFERENCE →](#) *Tag Reference Manual*.

### PLC NOT CONNECTED (02:FF) (02:F7)

Displays when communication with the PLC has stopped for over 60 seconds, when there is a transmission timeout error, or when there is excess *noise*.

Check the correspondence cable wiring and connect correctly.

---

\*1 For details about the T-File (trend graph) and A-File (alarm messages), refer to the *Tag Reference Manual*.

### PLC NOT RESPONDING (02:FE)

Displays when there is a Reply Timeout Error, or when there is excess noise.

The origin of the problem and the matching solutions are listed in the table below.

ORIGIN	SOLUTION
1. The power for the PLC host is not activated. 2. GP unit INITIALIZE setup (Setup I/O, PLC Setting) is incorrect. 3. The host and GP powering up process was incorrect. 4. The Communication Cable was not connected properly.	1. Turn On the host's power switch. 2. Setup the unit correctly and match up with the current host and Communication Cable. 3. Turn the host's power On first, wait 2-3 seconds, then power up the GP unit. 4. Check the Communication Cable wiring and connect it up properly.

### RECEIVE DATA ERROR (02:FD)

This problem arises as a result of one of these three:

- There is a problem in trying to receive the data
- The connected PLC and the PLC setup for the data is different
- Noise

These errors, except for noise, appear when the Communication Cable is pulled out when the GP unit is On, or when normal communication operations are being run, but the GP has been powered Off, then back On. To solve the problem, simply begin running transmissions again.

When the error is a result of noise, correct any improper connections.

### GP STATION NO. DUPLICATION ERROR (02:F9)

This error appears for one of two reasons:

- The GP number is same as the station number for another GP. Check all the GP station numbers.
- In the middle of correspondences, the PLC power has been turned On/Off. Reset the power on the PLC and GP.

### NETWORK ADDRESS ERROR (02:F8)

The SIO address setup for the GP is different from other GP's. Check the address setup for all the GP's.



## Run & Errors

### PLC COM. ERROR

Appears when the address setup for tags exceeds the address range on the host side. Check the Error Number that appears and use the following table to eradicate the problem.

PLC COM. ERROR ( 02 : x x )

└─ Error code (see the table below)

└─ Constant Value

Error #	Origin	Solution
FC	(MtoM type) There is a data format problem with the message received.	Check the data being transferred on the host side.
FB	The address set on a tag, the address used for storing data for Trend Graph, or the address registered with an alarm message is out of a set range. (address range error) * Memory to Memory type. * Siemen's PLC Series	* When using Memory to Memory Type: Set the addresses within the set range of the System Area (0~2047), then send the corrected information.  * When using Siemens' Series PLC Type: Set up the data block in the PLC where the System Data area is.
FA	Address range error	Set the addresses within the allowable device range.
53	When using a Matsushita Electronics PLC, and too many tags are used on the screen, the PLC cannot receive any data.	Decrease the number of screen tags.
51	The tag address, Trend graph data storage address, Alarm message Registry address, and the like, do not exist in the PLC's internal memory. (In the case of Fuji Electric PLC)	Setup the addresses in a device range that exists.
Others	When the Error Number displays, different for each PLC, look up the error number in the indicated PLC manual or, report the error number to the PLC maker.	



- Disregard the above table if Error Number **51** appears and you are using a PLC other than Fuji Electric. Look up the error contents in your PLC manual and follow the instructions therein.

- Disregard the above table if Error Number **53** appears and you are using a PLC other than Matsushita Electronics. Look up the error contents in your PLC manual and follow the instructions therein.

- In Hitachi's HIDIC H (HIZAC H) Series, the error code is divided into 2 bytes, whereas the GP Error Number is composed of 1 byte codes. (see next page)

E.g.                      Reply                      Return                      Display

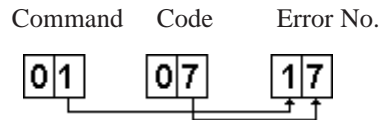

When the displayed error number is 8\*, or 5\*, use only the left column as the error number.

- In Toshiba's PROSEC T Series, the Error Code is 4 places long; on the GP, Error Numbers are displayed and changed into Hexadecimal.

E.g. 

0	1	3	4
---	---	---	---

 → 

8	6
---	---

- With the Allen-Bradley PLC-5 and SLC-500 Series, the EXT/STS error codes have been re-mapped to start at D0 HEX, so they will not conflict with other error codes. When looking up the error number in the PLC manual, subtract D0 h from the GP error code to get its error value.

E.g.	GP Error Code		PLC Error Code
	D1	→	01
	EA	→	1A

## SCREEN MEMORY DATA IS CORRUPT

Displays when the *checksum* of the screen memory data does not match because of a corruption in the screen files.

Error codes, as shown below, follow the error message. By referring to the error code, check the screens that have errors. When a screen file has been corrupted, delete that file, and make a new one (or recall a backup copy if available).

## SCREEN MEMORY DATA IS CORRUPT ( x x x x : x x x x )

<p>The Screen Number that has an error. (Displays only one per Screen Number.)</p>	<p>The number of screens that have errors (Decimal)</p>
--	---

## CLOCK SET UP ERROR

This message displays when the backup battery for the internal clock is dead. If the battery is incorrectly replaced, the battery may explode. To avoid the danger, please do not replace the battery yourself. When the battery needs a replacement, please consult with your local GP distributor.

After changing the backup battery, set up the internal clock. REFERENCE → Chapter 5, "Initialize".



The life span of the backup battery depends on the battery's ambient temperature and the amount of current being charged and used. The table below gives a general indication of how long the battery will last.

## Run & Errors

<b>Battery Temperature</b>	under 40° C	Between 40~ 50° C	Between 50~ 60° C
<b>Expected Life Span</b>	over 10 yrs.	over 4.1 yrs.	over 1.5 yrs

### SCREEN TRANSFER ERROR

Displays when an error occurs in the data transmission from the screen editor to the GP panel. Try re-transmitting the screen data.

### OBJ. PLC HAS NOT BEEN SETUP (02:F9)

The host PLC setup in GP's INITIALIZE Screen does not match the PLC in use. Use the Error Code that follows the error message to select the proper PLC type in the GP and correct the INITIALIZE setup.

OBJ. PLC HAS NOT BEEN SETUP ( x x )

|  
The PLC number (*Hexadecimal*)  
written onto the System File

*See the Table, next page.*

PLC Number indicated by error code

PLC #	File Ext.	PLC TYPE	PLC #	File Ext.	PLC TYPE
0	DL0	SYSMAC - C	18	DLO	FLEX-PC
1	DL1	MELSEC - AnN (Link)	1B	DLR	TC200
2	DL2	NEW SATELLITE JW	1F	DLU	SIEMENS S5 90-115
3	DL3	FA500	20	DLV	DIEMENS S5 135-115
4	DL4	MICREX-F	21	DLW	SIEMENS S5 3964(R) protocol
6	DL6	TOYOPUC-PC2	22	DLX	Allen Bradley PLC-5
7	DL7	MEWNET-FP	28	DLY	Allen Bradley SLC500
8	DL8	HIDIC-S10	63	DNQ	FA500M n:1 SIO
9	DL9	Memocon-SC	66	DNT	GP FANUC 90SNP
B	DLB	MELSEC-AnA (LINK)	67	DNU	HIZAC EC
D	DLD	SYSMAC-CV	68	DNV	IDIC 1
E	DLE	PROSEC EX2000	69	DNW	IDIC 2
10	DLG	HIZAC H	6A	DNX	IDIC3
11	DLH	MELSEC-FX	6B	DNY	FANUC Power Mate
12	DLI	MELSEC-F2	6C	DNZ	MICRO3
14	DLK	KOSTAC SG8	81	DOK	MELSEC-AnN (CPU)
15	DLL	PROSEC T	8B	DOU	MELSEC-AnA (CPU)
16	DLM	MEMORY LINK (SIO Type)			

# Chapter 7

## Maintenance

1. Regular Cleaning
2. Periodic Checkup
3. Changing the Backlight

### 7.1 Regular Cleaning

#### Cleaning the Display

When the surface or the frame of the display gets dirty, soak a soft cloth in water with a neutral detergent, wring the cloth tightly, and wipe the display.

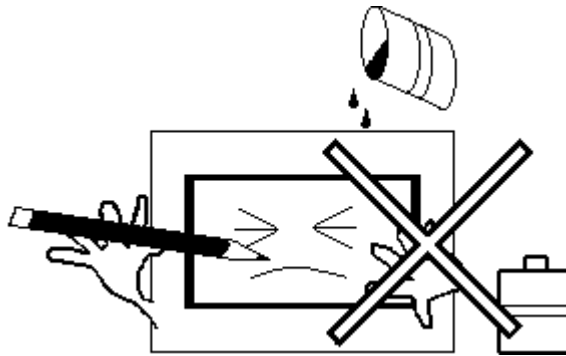

- Do not use paint thinner, organic solvents, or a strong acid compound to clean the unit.
- Do not press the touch-screen panel with hard or pointed objects, such as a mechanical pencil, for it may damage the surface.

#### Installation Gasket Replacement

This gasket protects the GP and improves its water resistance. For instructions on installing the gasket, **REFERENCE →** Chapter 3.1 "Installation".



A gasket, which has been used for a long period of time, may have scratches or dirt on it, and could have lost much of its water resistance. Change the gasket periodically (or when scratches or dirt become visible).

### 7.2 Periodic Maintenance Check Points

To maintain your unit in its best condition, please check your unit periodically.

#### Inspection Items:

##### Surrounding Environment

- Is the temperature within the allowable range? (0 to 50° Celsius)
- Is the humidity within the specified range? (20 to 85%RH)
- Is the atmosphere free of corrosive gas?

##### GP Temperature

- When the GP unit is mounted into a panel, the surrounding temperature refers to the temperature inside the cabinet.

##### Electrical Specifications

- Is the input voltage appropriate? (DC20.4 to 27.6V)

##### Attachments

- Is the cable connected properly? Not loose?
- Are the mounting brackets holding the unit securely?
- Are there many scratches or traces of dirt on the rubber gasket?

## 7.3 Changing the Backlight

Please have your service personnel do the replacement.



- Whenever changing the Backlight, be sure the power has been turned Off.
- When the unit is still On, high voltage runs through the *Backlight* area—*do not touch*.
- While the unit is still hot, be sure to wear cotton gloves to prevent injury.
- When the power has just been turned Off, the unit and Backlight are still very hot.



Be sure the backlight you order matches your GP type.

GP Type	Backlight Model No.
GP270-LG**	GP270-BL00-MS
GP270-SC**	

Change the Backlight following the steps below. Be sure to use gloves.

- 1) Turn off the GP's power supply.
- 2) Detach the GP's power cord terminals.( A )
- 3) Use a screwdriver to unfasten the case's top face attachment screws. ( B )
- 4) Open the GP's rear cover, and detach the backlight power connector.( C )
- 5) Push the backlight lock tab to the right and pull out the backlight.( D )
- 6) Insert a new backlight, and re-attach the power connector.
- 7) Use the GP's guide tabs to re-attach the GP's rear cover and tighten the attachment screws. Be careful not to pinch any of the connector wiring between the GP's front and the rear covers.( E )

Backlight Change Steps

