



SOLID. SPECIFIC. COMPLETE.

Wing Turn Catches from **NIELSEN SESSIONS** are used as latching hardware on heavy-duty cases in the military, electronics, telecommunications and entertainment industries. These durable, low-profile catches open by lifting and then twisting the handle (or "wing") 180° to disengage the hook. The catches allow quick and easy access to the inside of the case, while providing compressive force to seal and protect the contents from the external environment. Nielsen Sessions offers these high performance hardware products in a variety of materials, finishes, sizes and styles.



**Nielsen =
Sessions**
Hardware Made Easy

WING TURN CATCHES

WING TURN CATCHES — SMALL (0.25" travel)

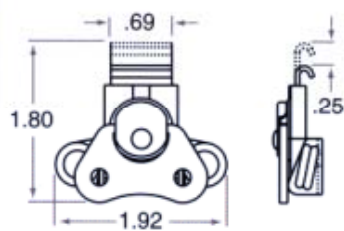

622-22 Base spring allows for misalignment between catch and strike

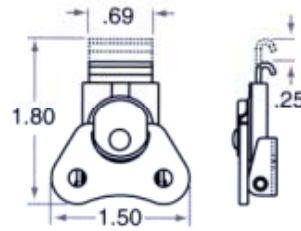

622-25 Basic catch

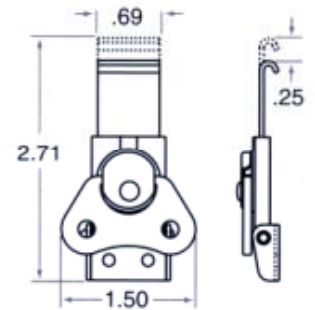

622-29 Long hook

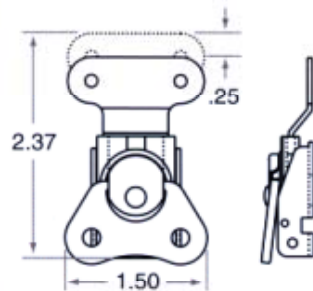

622-47 Hinged turn (integrated strike)

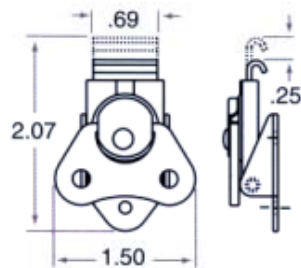

622-60 Long base

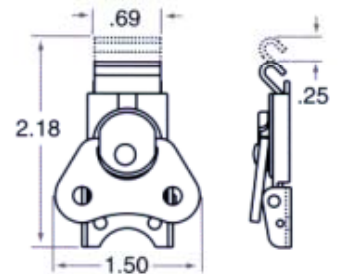

622-70 Upturned hook (low profile)

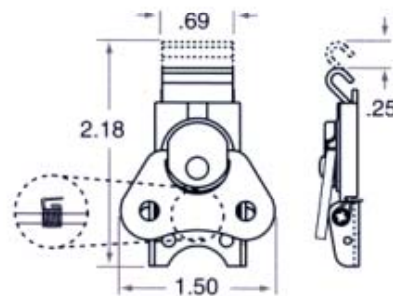

622-71 Kick-out spring (catch stays out of the way when unlatched)

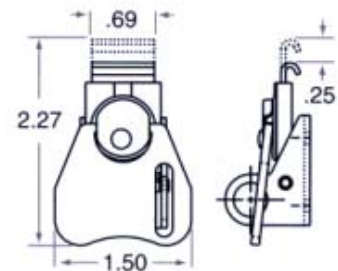

622-80 Can be used with a padlock

STRIKES FOR SMALL WING TURN CATCHES

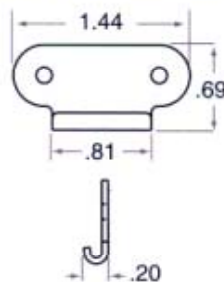

HS622-01 Small Strike

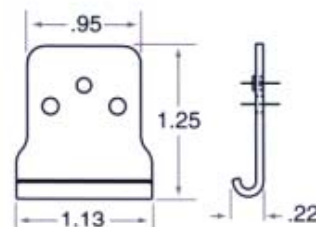

HS622-02 Small Strike

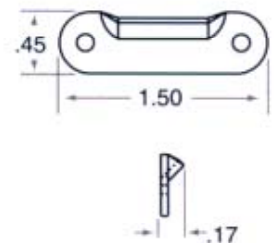

HS622-03 Concealed Strike



WING TURN CATCHES

WING TURN CATCHES - MEDIUM (0.31" travel)

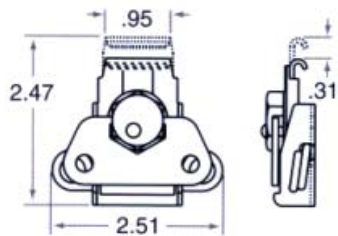

624-42 Base spring allows for misalignment between catch and strike, hexagonal cap

STRIKE FOR MEDIUM TURN CATCH

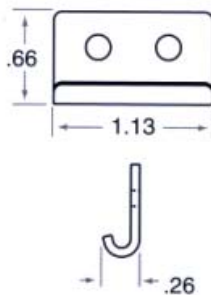

HS624-01 Medium Strike

WING TURN CATCHES — LARGE (0.36" travel)

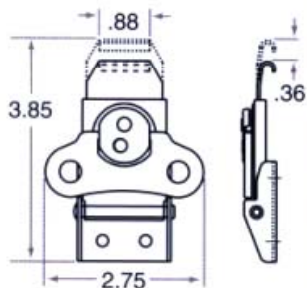

623-31 Large wing turn catch

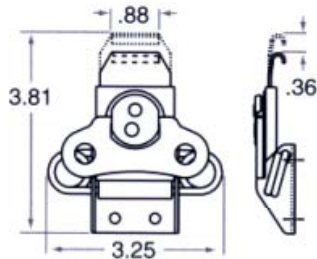

623-32 Base spring allows for misalignment between catch and strike

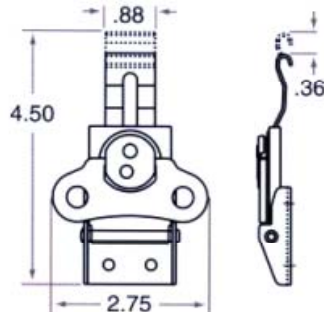

623-81 Can be used with a padlock

STRIKES FOR LARGE WING TURN CATCHES

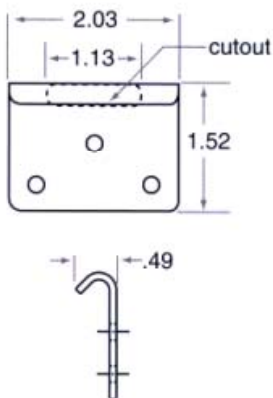

HS603-11 Large Strike

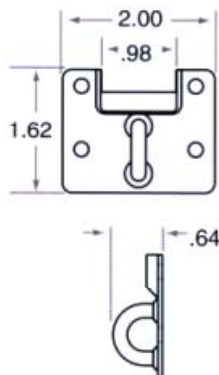

HS603-12 Used with 623-81

624-42



HS624-01



623-31



623-32



623-81



HS603-11



HS603-12



NIELSEN SESSIONS

770 Wethersfield Avenue
PO BOX 568
Hartford, CT 06141-0568
USA

tel: 800.291.3737

tel: 860.522.8145

fax: 860.525.0180

sales@nielsensessions.com
www.hardwaremadeeasy.com

**Nielsen =
Sessions**

Hardware Made Easy

CUSTOMIZATION Nielsen Sessions is a provider of engineering solutions for mechanical hardware applications. The products illustrated in this brochure are but a small sample of our manufacturing capabilities. If your application requirements are not met with a standard product, we will develop a custom product specifically designed to meet your needs.

MATERIALS & FINISHES The catches are offered in steel and stainless steel with a variety of finishes to meet environmental, performance and appearance requirements. Standard finishes for these products include zinc plating (also zinc-nickel, zinc-cobalt or cadmium) with a chromate sealer (in a variety of colors), e-coat, powder coat, passivation and black oxide. Other finishes are available upon request.

BACKGROUND Nielsen Sessions is a leading manufacturer of mechanical hardware such as catches and latches, handles, hinges, corners and clamps. With more than one hundred years experience in this field, Nielsen Sessions products are used in markets as diverse as electronics, military, industrial cleaning equipment, medical, electrical, telecommunications, lighting, vehicle access, vacuum / filtration, agricultural and industrial case / specialty enclosure (metal, plastic, composite). The quality management system at Nielsen Sessions is certified to the standards of ISO 9001:2000.

Nielsen Sessions is a division of Actuant Corporation (NYSE: ATU), a global manufacturer whose other businesses include Enerpac, Gardner Bender, Kopp, Milwaukee Cylinder, Power-Packer and Power Gear.