

# Some notions on humidity

**A**ir always contains a certain amount of water in the form of vapour. This determines the level of humidity in an atmosphere.

The capacity of the air to hold water vapour increases with temperature. This is why, in our homes, as soon as the temperature decreases, the vapour contained in the air condenses, as is evident on the colder surfaces in the room, such as the windows, walls etc.

The purpose of a dehumidifier is to remove the excess moisture from the air, avoiding the damage caused by condensation. Experts have established that the optimum environmental conditions for our well being and for the home are obtained between 40% and 60% relative humidity.

With temperatures near 0°C, you are recommended to heat the room even minimally. With heating, the condensation formed by the water vapour on windows and other cold surfaces evaporates into the air to be collected by the dehumidifier. Air leaving the dehumidifier is usually about 1°C warmer than room temperature.

## ELECTRICAL CONNECTION (U.K. ONLY)

- A) If your appliance comes fitted with a plug, it will incorporate a 13 Amp fuse. If it does not fit your socket, the plug should be cut off from the mains lead, and an appropriate plug fitted, as below. **warning:** Very carefully dispose of the cut off plug after removing the fuse: do not insert in a 13 Amp socket elsewhere in the house as this could cause a shock hazard. With alternative plugs not incorporating a fuse, the circuit must be protected by a 15 Amp fuse. If the plug is a moulded-on type, the fuse cover must be re-fitted when changing the fuse using a 13 Amp Asta approved fuse to BS 1362. In the event of losing the fuse cover, the plug must NOT be used until a replacement fuse cover can be obtained from your nearest electrical dealer. The colour of the correct replacement fuse cover is that as marked on the base of the plug.
- B) If your appliance is not fitted with a plug, please follow the instructions provided below:

**WARNING - THIS APPLIANCE MUST BE EARTHED  
IMPORTANT**

The wires in the mains lead are coloured in accordance with the following code:

Green and yellow	Earth
Blue	Neutral
Brown	Live

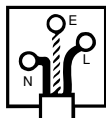

As the colours of the wires in the mains lead may not correspond with the coloured markings identifying the terminals in your plug, proceed as follows:

The green and yellow wire must be connected to the terminal in the plug marked with the letter E or the earth symbol  or coloured green or green and yellow.



The blue wire must be connected to the terminal marked with the letter N or coloured black.

The brown wire must be connected to the terminal marked with the letter L or coloured red.

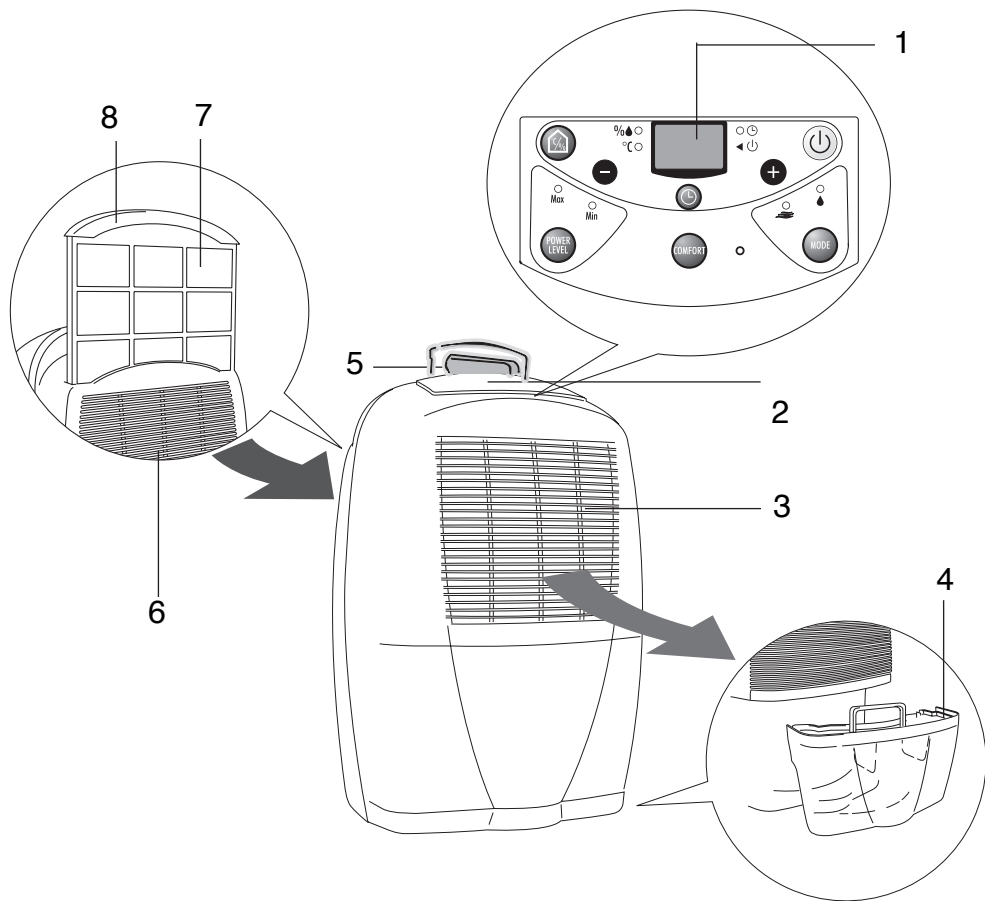
# Description/Accessories



- 1. Control panel
- 2. Control panel cover
- 3. Air outlet grille
- 4. Condensate collection tank
- 5. Lifting handle
- 6. Air intake grille
- 7. Electrostatic filter (some models only)
- 8. Air filter

Accessories	Description
	condensate drain hose (2 m.) (some models only)
	rubber bung

# Warnings

## Warnings

- Use this appliance only as described in this instruction manual.  
As with all electrical equipment, whilst the instructions aim to cover as many eventualities as possible, caution and common sense should be applied when operating and installing this appliance.
- This appliance is designed to dehumidify residential environments and must not be used for other purposes.
- It is dangerous to modify or alter the characteristics of the appliance in any way.
- If the appliance requires repair, always contact a Service Centre authorised by the manufacturer. Always insist on original spare parts. Repairs carried out by unauthorised personnel may be dangerous and invalidate the guarantee.
- This appliance must be used exclusively by adults. Children should not be allowed to play with this appliance.
- Children or infirm persons should not be allowed to use this product unsupervised.
- The appliance must be installed in conformity with the relevant national legislation.
- If the power cable is damaged, it must only be replaced by specialist personnel.
- The appliance must be connected to an efficient earth system. Have your electrical circuit checked by a qualified electrician.
- Do not use extension power cables.
- Before cleaning or maintenance operations, always unplug the appliance from the mains.
- Do not move the appliance by pulling the power cable.
- Do not install the appliance in rooms containing gas, oil or sulphur. Do not install near sources of heat.
- Do not use the appliance on inclined surfaces.
- Keep the unit at least 50 cm away from inflammable substances (alcohol etc) or pressurised containers (eg. aerosol cans).
- Do not rest heavy or hot objects on top of the appliance.
- Clean the air filter regularly.
- Always transport the appliance upright or resting on one side.  
Remember to drain the tank before moving the appliance. Wait at least 1 hour after transporting the appliance before starting it.
- R134a is a refrigerant that complies with the EEC environmental standards; nonetheless, the refrigerant circuit on the machine should not be perforated. At the end of its working life, consign the air conditioning unit to a special collection centre.
- The materials used for packaging can be recycled. You are therefore recommended to dispose of them in special differentiated waste collection containers.
- Do not use the appliance outdoors.
- Do not obstruct the air intake or outlet.

## Technical service

Keep the list of Service Centres and identify the Centre nearest you.

## Electrical connections

**After moving the appliance, wait at least an hour before turning it on again.**

Before plugging the appliance into the power socket, check that:

- The mains power supply corresponds to the power supply indicated on the rating plate.
- The power socket and electrical circuit are adequate for the appliance.
- The power socket matches the plug. If this is not the case, have the plug replaced by a qualified electrician.
- The power socket must be adequately earthed.

# Installation

**P**osition the appliance in the room to be dehumidified.

A free space of at least 50 cm must be left at the front of the dehumidifier, so as not to block the air outlet. For efficient ventilation a space of about 5-10 cm should be left at the back of the appliance.

The condensate can be drained in one of the following ways:

## A) Draining into the tank

The condensate can be drained directly into the tank (fig. 1)

The tank can be easily removed and has a handle making it simple to carry and empty (fig. 1).

fig. 1

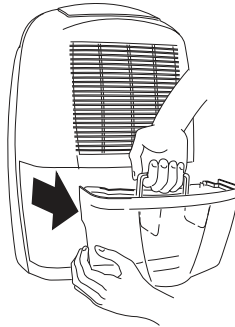

## B) Continuous external draining

If the appliance is to be operated for long periods but you are unable to empty the tank regularly, you are recommended to use the continuous drain facility.

- 1) Drill the inside of the drain spout using a narrow drill bit. (Fig. 2)
- 2) Fasten the rubber hose to the spout. For models without drain hoses supplied, we suggest you purchase a rubber hose around 2m long, with an internal diameter of 9.5 mm.
- 3) Make sure that the hose is not higher than the spout. In caso contrario l'acqua resterà nella tanica; verificare inoltre che il tubo non sia strozzato (Fig. 3), or water could remain in the tank. Check the hose is not choked (Fig. 3).

N.B.: Keep the rubber bung. You will need it to plug the hose or close the spout if you revert to draining into the tank. (see point A).

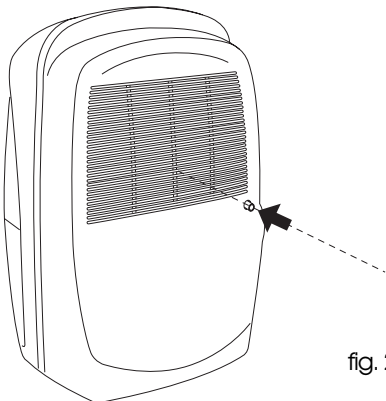

fig. 2

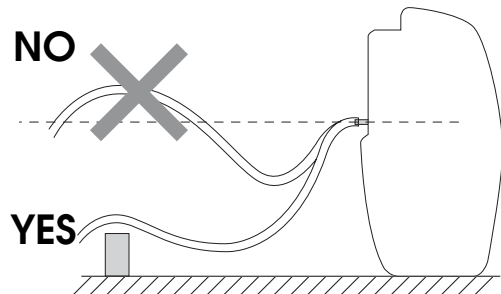
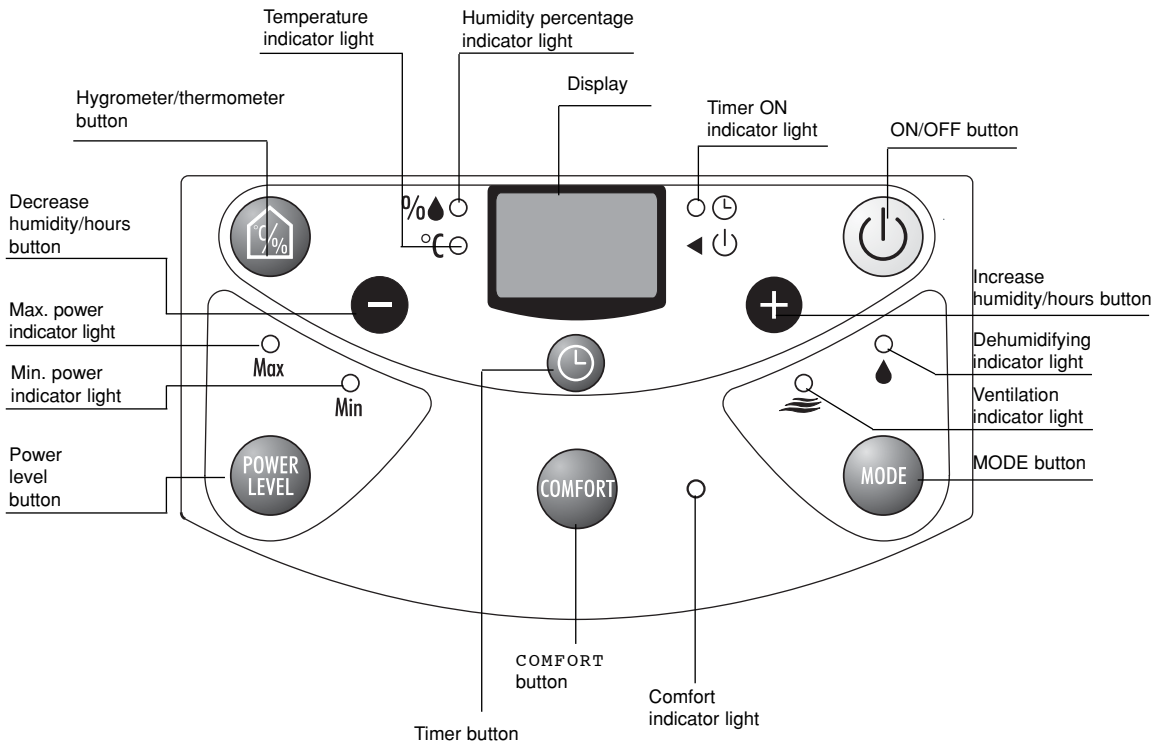

fig. 3

# How to dehumidify



## “ON/OFF” button

Starts the appliance.

## “MODE” button

Selects the “dehumidification” function or the “ventilation” function.

## “COMFORT” button

Activates the “COMFORT” function. When the “COMFORT” function is activated, pressing the button again deactivates it.

# The buttons



## “P” POWER LEVEL” button

Selects the power level (MIN/MAX).



## Hygrometer/thermometer button

Displays, in sequence for 2 secs., the ambient humidity, with a tolerance of +/- 5% (“%” light flashing) and the ambient temperature, with a tolerance of +/- 1% (“°C” light flashing).



## Timer button

Sets the number of appliance operating hours (maximum 24).



## Increase/decrease humidity/hours

Adjusts the desired humidity level in 5% steps and sets the timer.

## Display

Meaning of the codes that may be shown on the display:

1. “- -” Indicates that the appliance is in Standby mode.
2. “CT” Indicates that the appliance is operating in “COMFORT” mode.
3. “FT” Indicates that the tank is not fitted, is full or is positioned incorrectly.
4. “DF” Indicates that the appliance is operating at low temperature. In this mode, ventilation cycles are alternated with dehumidification cycles to avoid the formation of frost. For use in particularly cold environments, heating is recommended so as to raise the ambient temperature even by just a few degrees. This allows the dehumidifier to operate in conditions that improve its performance and accelerate the dehumidification process.
5. “PF” Indicates that there may be a fault with the probes, or that the ambient humidity is low.
6. “FN” Indicates that the appliance is operating in ventilation mode.

# The indicator lights

## **H**umidity percentage indicator light

If on indicates that the display is showing the humidistat reading.

If flashing, indicates that the display is showing, for 2 secs., the ambient humidity (pressing the thermometer/hygrometer button).

## **T**emperature indicator light

Slf flashing, indicates that the display is showing, for 2 secs., the ambient temperature (pressing the thermometer/hygrometer button, after the ambient humidity reading).

## **T**imer indicator light

If on indicates that the timer function is active.

## **D**ehumidifying indicator light

Indicates that the appliance is operating in dehumidification mode.

## **V**entilation indicator light

Indicates that the appliance is operating in ventilation mode.

## **Min** **M**inimum power indicator light

Indicates that the MIN power level has been selected.

## **Max** **I**ndicates that the MAX power level has been selected

Indicates that the MAX power level has been selected.

## **COMFORT** **C**omfort indicator light

Indicates that the appliance is operating in comfort mode. When this is on, all the other indicator lights are off, except for the timer indicator light, if the function is active.

# Selecting the functions

## How to dehumidify (dehumidification only function)

- 1) Plug the appliance into a mains socket.
- 2) The display shows "--" to indicate that the appliance is in standby and therefore ready for operation. If the message "FT" is displayed, empty the tank or position it correctly.
- 3) Press the ON/OFF button.
- 4) Press the "mode" button and choose the dehumidification function ("💧" indicator light on). The display shows the relative humidity set point.
- 5) Press the "+" or "-" button to set the desired humidity (30% means a dry environment, 80% a humid environment).
- 6) Press the "power level" button to select the desired dehumidification power level (MIN/MAX).
- 7) Press the "🌡️" button to display, in sequence, the ambient relative humidity ("%💧" indicator light flashing) and the ambient temperature ("°C" indicator light flashing).
- 8) When the appliance reaches the humidity set point, it will stop and the periodical ventilation function will start, so as to ensure a correct relative humidity reading. As soon as the humidity increases above the set point, the appliance will automatically resume dehumidification operation.

## How to use as a ventilator

- 1) Plug the appliance into a mains socket.
- 2) The display shows "--" to indicate that the appliance is in standby and therefore ready for operation. If the message "FT" is displayed, empty the tank or position it correctly.
- 3) Press the ON/OFF button.
- 4) Press the "mode" button and choose the purification function ("🌀" indicator light on). The display shows "FN".
- 5) Press the "🌡️" button to select the desired heating power level (MIN/MAX).

## COMFORT function

This is an automatic dehumidification function. In this mode, on the basis of room temperature, the appliance establishes the ideal level of well-being and power level to use. The display shows "CT". Neither the humidity nor the power level can be changed.



# Cleaning/Warnings

## Maintenance

Always unplug the appliance from the power socket before performing any cleaning or maintenance operations.

For safety reasons, never wash the dehumidifier using a jet of water.

## Cleaning the cabinet

- Clean the appliance using a damp cloth then dry with a dry cloth.
- Never use petrol, alcohol or solvents to clean the appliance.
- Never spray liquid insecticide or similar products as they may deform the plastic.

## Cleaning the air filter

If the filter is dirty, air circulation is compromised and the efficiency of the dehumidifying and air purifying functions decreases. It is therefore good practice to clean the filter at regular intervals. The frequency depends on the duration and conditions of operation. If the unit is used constantly or systematically, you are recommended to clean the filter once a week.

- To remove the air filter, extract by pulling (fig. 4).
- Use a vacuum cleaner to remove dust accumulations from the filter. If the filter is very dirty, wash in warm water and rinse several times.

The temperature of the water must not exceed 40°C. After washing the filter, allow it to dry completely before repositioning it.

## If the appliance is not used for long periods

- Unplug from the mains socket and empty the tank.
- Clean and reposition the filter.
- Cover the appliance with a plastic bag so that dust does not build up.

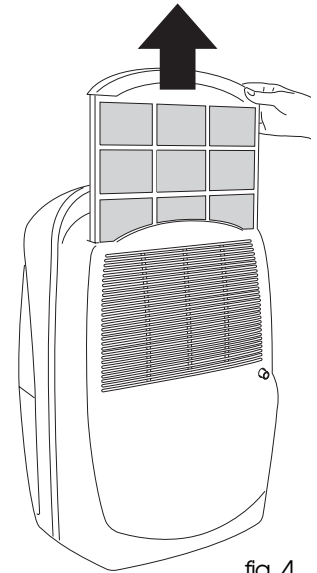

fig. 4

# Troubleshooting

Check the following points before calling your local authorised Service Centre.

Problem	Cause	Solution
The appliance is operating in dehumidification mode (indicator light on), but the humidity does not decrease	<ul style="list-style-type: none"> <li>•filter clogged</li> <li>•the temperature or humidity of the room is too low</li>   <li>•the room is too large</li> <li>•too many sources of humidity in room (boiling pots etc.)</li> <li>•humidistat set too high</li> </ul>	<ul style="list-style-type: none"> <li>•clean the filter</li> <li>•in certain conditions, it is normal for the appliance not to dehumidify (in these cases the room being dehumidified should also be heated)</li>   <li>•decrease the humidity set point</li> </ul>
The appliance does not work for around 3 minutes when restarted	<ul style="list-style-type: none"> <li>•the appliance's safety device has been activated</li> </ul>	<ul style="list-style-type: none"> <li>•wait for 3 minutes</li> </ul>
<p>The display shows "FT"</p> <p>The display shows "DF"</p> <p>The display shows "FP"</p>	<ul style="list-style-type: none"> <li>•the tank is missing</li> <li>•the tank is full</li> <li>•the tank is in the wrong position</li>   <li>•the temperature in the room is too low</li>   <li>•one of the sensors on the appliance is faulty</li> </ul>	<ul style="list-style-type: none"> <li>•position the tank</li> <li>•empty the tank</li> <li>•position the tank correctly</li>   <li>•increase the ambient temperature</li>   <li>•call the Service Centre</li> </ul>

# Technical specifications

Power supply voltage  
 Absorbed power  
 Maximum power input  
 Absorbed current  
 Frost protection device  
 Humidistat  
 Fan speeds  
 Air filter  
 Dimensions WxHxD  
 Tank capacity

Operating limits:

- temperature
- relative humidity

<b>DEC180E</b>	
	See rating plate
	"
	"
	"
	yes
	yes
	2
	yes
	570x360x300mm
	4 litres
	<b>dehumidification</b>
	2° - 32°
	30 - 95%